

Echo77F-PoER USER

3rd Gen Intel[®] Core[™] Mobile i7/i5/i3, Ivy Bridge
Extended Temp. Fan-less Embedded Controller

Manual

Worldwide Technical Support and Product Information

www.CappuccinoPC.com

Unicomp Labs, Inc

46 Cain Drive, Brentwood, NY 11717

Tel: 631-231-1800

Fax: 631-231-4842

For further support information, refer to the Technical Support and Professional Services appendix. To comment on Unicomp Labs, Inc. documentation, refer to the Unicomp Labs, Inc. web site at www.CappuccinoPC.com.

© 2014 Unicomp Labs, Inc. All rights reserved.

Record of Revision

Version	Date	Page	Description	Remark
V1.0.0	April 02, 2013	All	Preliminary Release	
V1.0.1	April 10, 2014	P3	CPU List	

Disclaimer

This manual is intended to be used as a practical and informative guide only and is subject to change without prior notice. It does not represent commitment from Unicom Labs, Inc. Unicom shall not be liable for direct, indirect, special, incidental, or consequential damages arising out of the use of the product or documentation, nor for any infringements upon the rights of third parties, which may result from such use.

Declaration of Conformity

FCC This equipment has been tested and found to comply with the limits for a Class A digital device, pursuant to part 15 of the FCC Rules. These limits are designed to provide reasonable protection against harmful interference when the equipment is operated in a commercial environment. This equipment generates, uses, and can radiate radio frequency energy and, if not installed and used in accordance with the instruction manual, may cause harmful interference to radio communications. Operation of this equipment in a residential area is likely to cause harmful interference in which case the user will be required to correct the interference at his own expense.

CE The product(s) described in this manual complies with all applicable European Union (CE) directives if it has a CE marking. For computer systems to remain CE compliant, only CE-compliant parts may be used. Maintaining CE compliance also requires proper cable and cabling techniques.

Copyright and Trademarks

This document contains proprietary information protected by copyright. All rights are reserved. No part of this document may be reproduced by any mechanical, electronic, or other means in any form without prior written permission of the manufacturer. Company/product names mentioned herein are used for identification

Order Information

Part Number	Description
Echo77F-PoER	Fanless Embedded System with 6 GbE LAN, 2 SO-DIMM, 4 COM, 4 USB 3.0, 2 SATA III SSD/HDD, Isolated DIO, 4-Port Gigabit PoE+

Optional Accessories

Part Number	Description
DDR3-4GB-Wide	DDR3 4GB 1333/1066MHz RAM, Wide Temperature -40°C ~ +85°C
KVR1333D3S9/8G	Kingston® DDR3 8GB PC1333 RAM
KVR1333D3S9/4G	Kingston® DDR3 4GB PC1333 RAM
PWA-120WM4P	120W, 24V, 90VAC to 264VAC power adapter
SCSI-20P	20-pin SCSI Cable, 1M
TMB-SCSI	Terminal Board with One 20-pin SCSI Connector and DIN-Rail Mounting
WiFi Module	Intel MiniPCIe WiFi Module with Antenna

Table of Contents

Disclaimer	iv
Declaration of Conformity	iv
Copyright and Trademarks	iv
FCC	iv
CE	iv
Order Information	v
Optional Accessories	v
General Introduction	1
1.1 Overview	1
1.2 Product Specification	2
1.2.1 Specifications of Echo77F-PoER	2
1.3 Supported CPU List	3
1.4 Mechanical Dimension	4
Getting to Know Your Echo77F-PoER	5
2.1 Packing List	5
2.2 Front Panel I/O Functions	5
2.2.1 Audio Jacks	5
2.2.2 Dual USB 3.0	6
2.2.3 Dual USB 2.0	6
2.2.4 10/100/1000 Mbps Ethernet Ports	7
2.2.5 Dual Display Port	8
2.2.6 DVI-D/HDMI Connector	8
2.2.7 VGA Connector	9
2.2.8 PWR and HDD LED Indicators	10
2.2.9 CFast Card	10
2.2.10 Power Button	11
2.2.11 Reset Tact Switch	11
2.3 Rear Panel I/O Functions	12
2.3.1 DC-In 6~36V Mini DIN or Power Terminal Block	12
2.3.2 Remote Power On/Off Switch	12
2.3.3 Isolated 8 DI / 8 DO	13
2.3.4 Serial Port COM2	15
2.3.5 Serial Port COM1/COM3 / COM4	15
2.3.6 PoE, Power over Ethernet Ports	16
2.4 Main Board Expansion Connectors	17
2.4.1 J1 Miscellaneous Pin Header	19
2.4.2 CN23, CN25, J4 LVDS	19
2.4.2 CN23, CN25, J4 LVDS	20
2.4.3 CN17, CN20 SATA3 & CN21 SATA Power Connector	22
2.4.4 CN13 SATA-II Connector J3 SATA DOM Power Connector	24
2.4.5 J2 Internal USB Dual Port	26
2.4.6 CN8, CN14 Mini-PCIe, mSATA Connectors	27
2.4.7 CN16 GPIO	29
2.4.8 FAN1	30
2.4.9 CN27, CN28 SUMIT	31
2.4.10 Battery	32

2.5 Main Board Jumper Setting	33
2.5.1 JP3 LVDS Backlight Power Selection	34
2.5.2 JP2(A) CMOS Clear Jumper Setting	35
2.5.3 JP2(B) ME Clear Jumper Setting	36
2.5.4 JP1 AT/ATX Power Mode Jumper Setting	37
System Setup	38
3.1 Install DDR3 / DDR3L SODIMM Modules	38
3.2 Install HDD	39
3.3 Install MiniPCle Cards	41
3.4 Install SATA DOM	42
3.5 Mount Your Echo77F-PoER	
BIOS and Driver	46
4.1 BIOS Settings	46
4.1.1 Main Menu	47
4.1.2 Advanced Function	47
4.1.3 Chipset Function	52
4.1.4 Boot Function	53
4.2 Operating System	53
4.3 Driver Installation	54
4.3.1 Chipset Driver Installation	54
4.3.2 Intel HD 4000 Graphics Driver Installation	55
4.3.3 Network Device Driver Installation	55
4.3.4 Audio Driver Installation	56
4.3.5 USB 3.0 Driver Installation	56
4.3.6 Storage Support Software Installation	57
4.3.7 Intel AMT Function Support	57
Appendix A : Isolating DIO Guide	58
Appendix B : GPIO & WDT Function	60
A. Entry MB PnP Mode	60
B. Located on Logical Device 7	60
C. Access the Super I/O Register	60
D. Start to Access the Echo77F-PoER GPIO Port	
E. WDT ON/OFF and Timer-Counter setting	61

1

General Introduction

1.1 Overview

Echo77F-PoER support 3rd Gen Intel® Quad-Core™ series processor (6M Cache, up to 3.30 GHz), DDR3L and DDR3 maximum dual channel 16GB ram, DVI-D/HDMI and VGA dual display, 4 independent gigabit PoE (Power-over-Ethernet) ports, 2 GbE LANs, CFast, two 2.5" SATA 6Gp/s HDD/SSD trays, JST connector, and 2 miniPCI-express, plus with Trusted Platform Module.

Using only one Ethernet cable to supply power and transmit and sync data simultaneously, Echo77F-PoER apply IEEE 802.3at power sourcing equipment enable to supply 50 to 57 VDC, 600 mA, and 25.5W at the powered device, for example, HD LCDs, touchscreens, cameras and motion sensors.

Design for wider compatibility, higher power supply but less total cost and wiring, Echo77F-PoER is one-of-a-kind dream fan-less embedded system for machine Vision, outdoor imaging, 3-D imaging, ITS (Intelligent Traffic Solutions), quality control, and medical imaging applications.

1.2 Product Specification

1.2.1 Specifications of Echo77F-PoER

System	
Processor	3 rd Generation Intel® Quad Core™ i7/i5/i3 Ivy Bridge Processors (6M Cache, up to 3.30 GHz)
Chipset	Intel® QM77
BIOS	AMI
SIO	IT8783F
Memory	DDR3 1066/1333/1600 MHz, DDR3L 1066/1333 MHz, Max. 16GB 2 204-pin SO-DIMM Sockets
I/O Ports	
Serial Interface	3 COM RS-232, 1 COM RS-232 / 485 / 422
USB	4 USB 3.0, 2 USB 2.0, 2 Internal USB 2.0
Isolated DIO	8 DI, 8 DO
LED	Power, HDD and CFast LEDs
GPIO	16 GPIO
Expansion	
Mini PCIe	1 miniPCIe Socket: PCIe + USB + SIM Card Socket 1 miniPCIe Socket: PCIe + USB
SUMIT A, B	2 SUMIT Slots (Optional)
JST Connector	1 Internal 6-pin (Internal USB 2.0)
Graphics	
Chipset	Intel® GMA HD 4000
Display Memory	Shared Memory, Up to 1.7GB
Interface	DB-15 VGA / 1920 x 1200 Max., DVI-D / 1920 x 1200 Max., Display Port 1 / 2560 x 1600 Max., Display Port 2 / 1920 x 1200 Max., LVDS / Dual Channel 24-bit / 1920 x 1200 Max.
Storage	
SATA	2 SATA III 6Gbps 1 SATA II 3Gbps - Support Horizontal Type SATA DOM
mSATA	2 SATA II 3Gbps
Storage Expansion	CFast Slot Push In / Out Ejector
Audio	
Audio Codec	Realtek ALC892, 5.1 Channel HD Audio
Audio Interface	Line-in, Line-out, Mic-in, Front Audio Header
Ethernet	
LAN1	Intel® 82579LM Gigabit LAN, Wake on LAN, PXE Support
LAN2	Intel® 82574L Gigabit LAN, Wake on LAN, PXE Support
Power over Ethernet	
	4 Gigabit IEEE 802.3at (25.5W / 48V) PoE Ports by Intel® 82574L
Power	
Power Input	1 Mini DIN, One 3-pin Terminal Block for DC-IN : V+, V-, Frame Ground
Power Input Voltage	DC-IN 6 ~ 36V
Power Adapter	AC to DC +24V / 5A 120W Max. (Optional)
Protection	On-board LT4356 for Power Input High Voltage Surge Protection
Other	
Trusted Platform Module (TPM)	Infineon SLB9635, LPC interface (Optional)
Watchdog Timer	Reset: 1 to 255 sec / min Per Step
HW Monitor	Temperature / Voltages Auto Throttling Control When CPU Overheats
Mechanical	
Chasis Construction	Aluminum Housing
Size (W x D x H)	260mm x 215mm x 79mm (10.2" x 8.5" x 3.1")
Weight	2.8 Kg (6 lb)
Mounting	Wall-mount by Mounting Bracket
Environmental	
Operating Temperature	-25°C to 70°C (-13°F to 157°F)
Storage Temperature	-40°C to 85°C (-40°F to 185°F)
Humidity	10% to 95% Humidity, Non-condensing
Relative Humidity	95% at 70°C
Vibration	Random: 0.5Grms @5~500 Hz according to IEC68-2-64 Sinusoidal: 0.5Grms @5~500 Hz according to IEC68-2-64
Shock	Operating, 20 Grms, Half-sine 11 ms Duration (w / SSD, According to IEC60068-2-27)
EMC	CE, FCC, RoHS, EN50155 & EN50121-3-2

1.3 Supported CPU List

Echo77F-PoER accepts 3rd generation Intel® i7/i5/i3 processors via a rPGA988B CPU socket. The following processors have been tested by Unicom Labs, Inc. for the compatibility with Echo77F-PoER. Instead of i7-3610QE, i5-3610ME and i3-3120ME, You may also select other processor according to your consideration of application and performance.

Series		Max. TDP	iAMT	Embedded
i7	3840QM	45W	√	
	3820QM	45W	√	
	3740QM	45W	√	
	3720QM	45W	√	
	3632QM	35W		
	3630QM	45W		
	3612QM	35W		
	3610QE	45W	√	O
	3610QM	45W		
	3540M	35W	√	
	3520M	35W	√	
i5	3610ME	35W	√	O
	3380M	35W	√	
	3360M	35W	√	
	3340M	35W	√	
	3320M	35W	√	
	3230M	35W		
	3210M	35W		
i3	3130M*	35W		
	3120ME	35W		O
	3120M*	35W		
	3110M*	35W		

The processors with "O" are listed in Intel® Embedded Roadmap and with a 7-year life cycle support (from 2011 to 2017). The processors with "*" the maximum operation temperature is 55°C.

1.4 Mechanical Dimension

Figure 1.1 Echo77F-PoER

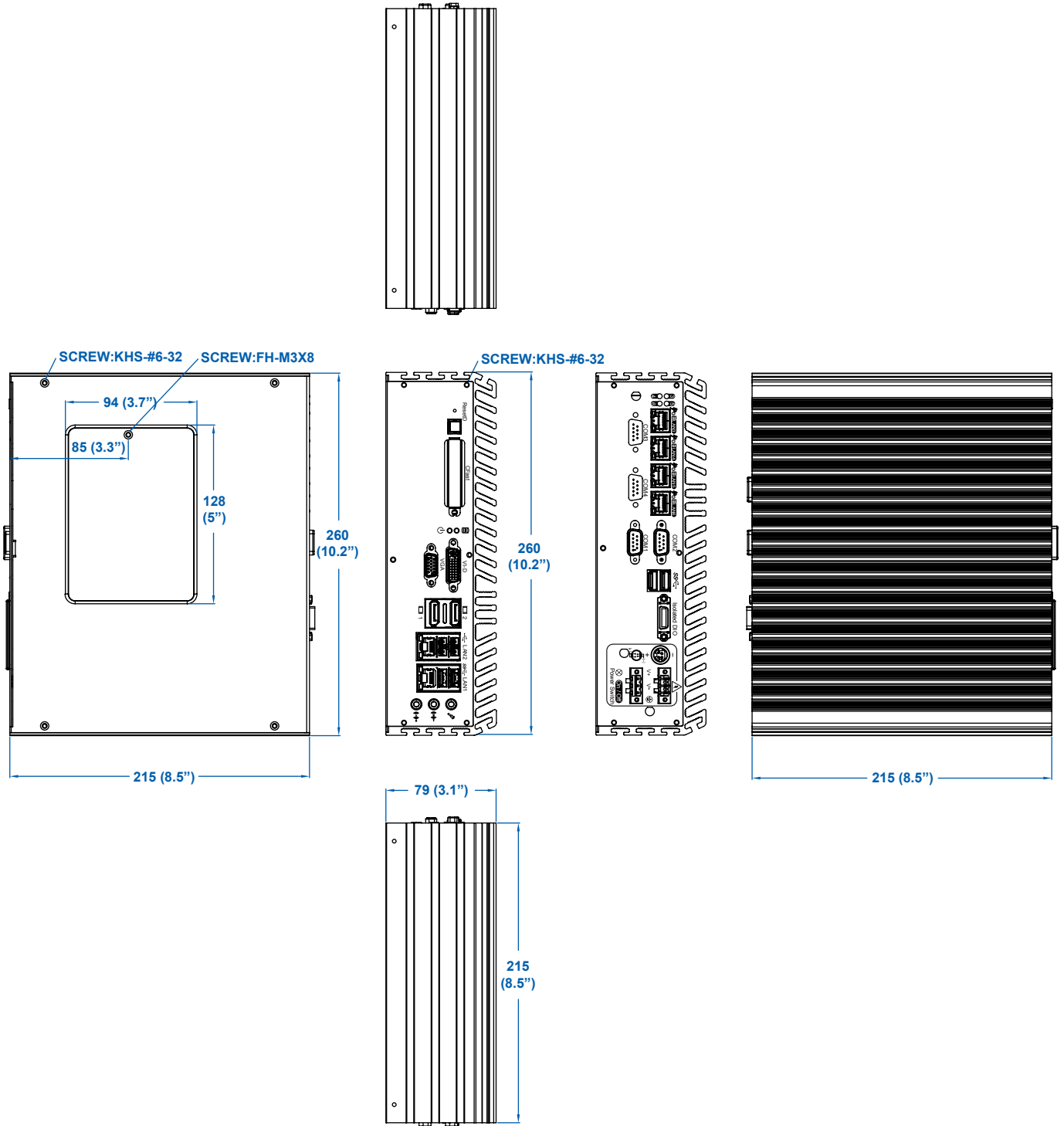

2

Getting to Know Your Echo77F-PoER

2.1 Packing List

Item	Description	Qty
1	Echo77F-PoER fanless controller (According to the configuration you order, the Echo77F-PoER may contain HDD and DDR3 SO-DIMM. Please verify these items if necessary.)	1
2	Accessory box, which contains <ul style="list-style-type: none">• Drivers & Utilities DVD• Wall-mounting bracket• M4 screws for wall-mounting bracket• 4-pin pluggable terminal block	1 2 4 2

2.2 Front Panel I/O Functions

2.2.1 Audio Jacks

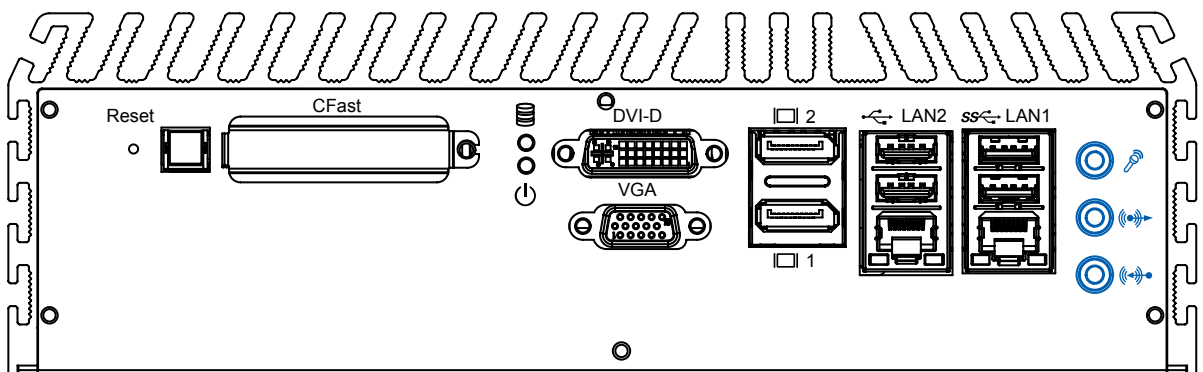

The Echo77F-PoER offers stereo audio connector of MIC , Line_In and Line_Out. The audio chip controller is by ALC892 which is compliant with the Intel® Azalia standard. To utilize the audio function in Windows, you need to install corresponding drivers for both Intel QM77 chipset and Realtek ALC892 codec. Please refer to Section 4 for information of driver installation.

2.2.2 Dual USB 3.0

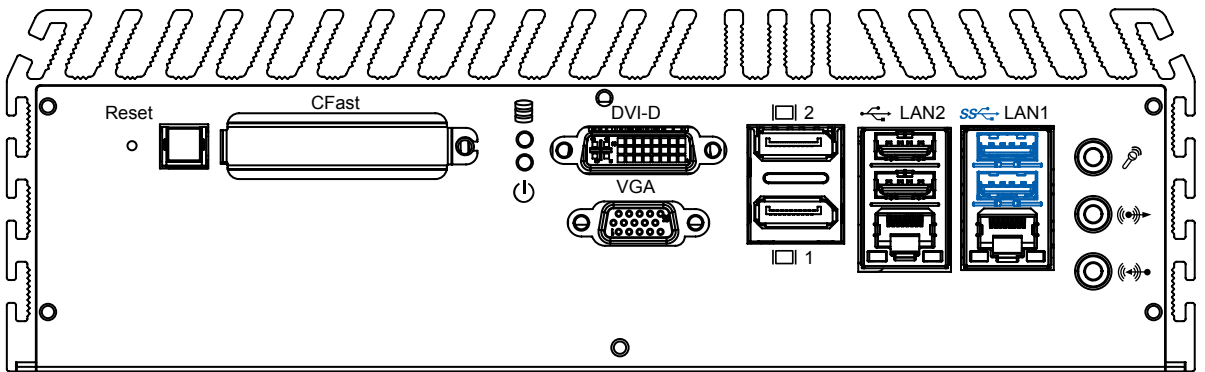

The Echo77F-PoER comes with 2 USB 3.0 hosts on the front panel. These USB 3.0 ports allow data transfers up to 5 Gb/s. The controller supports SuperSpeed (SS), high-speed (HS), full-speed (FS) and low-speed (LS) traffic on the bus.

2.2.3 Dual USB 2.0

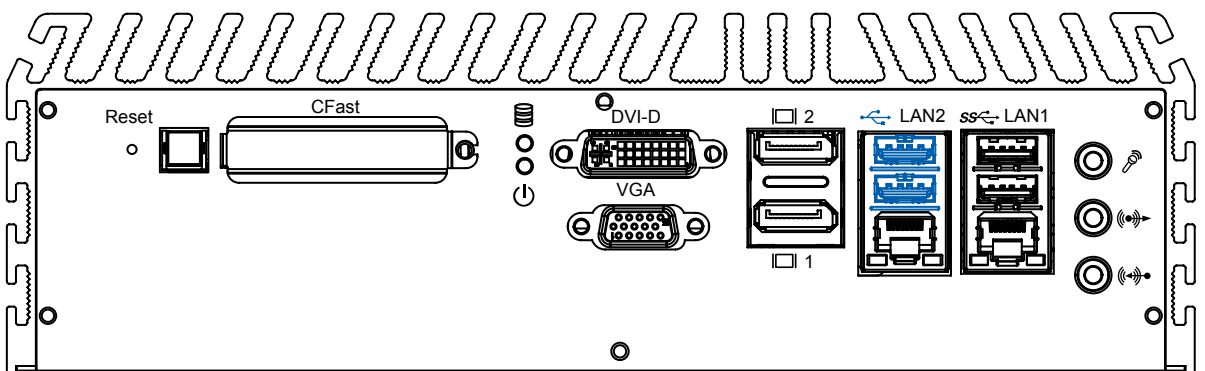

The Echo77F-PoER comes with 2 USB 2.0 hosts on the front panel. The USB interface supports Plug and Play, which enables you to connect or disconnect a device whenever you want, without turning off the system. The hosts can be used for an external flash disk or hard drive for storing large amounts of data. You can also use these USB hosts to connect to a keyboard or a mouse. The following diagram shows the pinouts for USB1 and USB2 port.

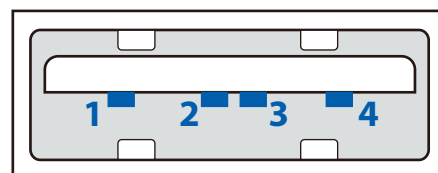

Pin Number	1	2	3	4
USB1	+5V	USB1-	USB1+	GND
USB2	+5V	USB2-	USB2+	GND

2.2.4 10/100/1000 Mbps Ethernet Ports

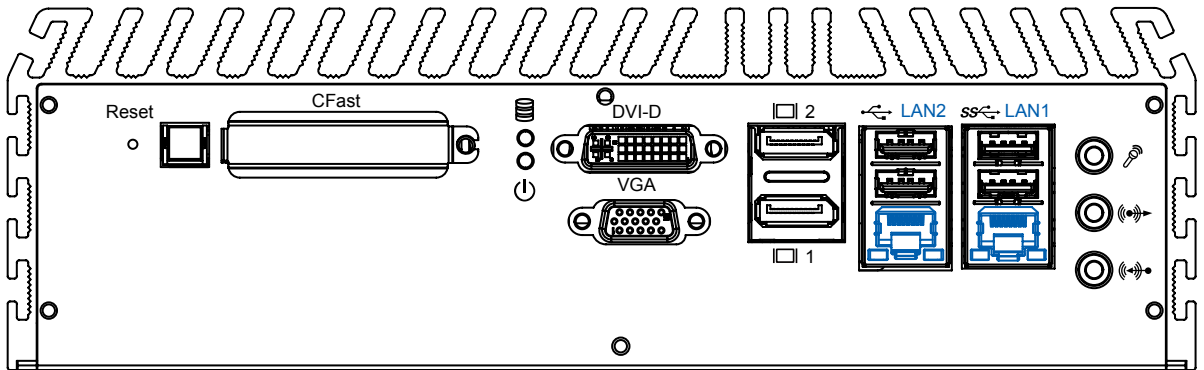

The 10/100/1000 Mbps Ethernet LAN ports 1 and 2 use 8-pin RJ-45 connector. LAN1 is equipped with Intel 82579LM for AMT function. LAN2 is equipped with Intel 82574L. Using suitable RJ-45 cable, you can connect Echo77F-PoER system to a computer, or to any other piece of equipment that has an Ethernet connection, for example, a hub or a switch. Moreover, both of them have Wake-on-LAN and Preboot Execution Environment capabilities. The following diagram shows the pinouts for LAN1 and LAN2 port.

Pin No.	10 / 100 Mbps	1000 Mbps
1	E_TX+	MDIO_P
2	E_TX-	MDIO_N
3	E_RX+	MDI1_P
4	----	MDI2_P
5	-----	MDI2_N
6	E_RX-	MDI1_N
7	-----	MDI3_P
8	-----	MDI3_N

The Ethernet ports use standard RJ-45 jack connectors with LED indicators on the front side to show Active/Link status and Speed status. The LED indicators on the right bottom corners glow a solid green color when the cable is properly connected to a 100 Mbps Ethernet network. The LED indicator on the left bottom corner will flash on and off when Ethernet packets are being transmitted or received.

The LED indicators on the right bottom corners glow a solid orange color when the cable is properly connected to a 1000 Mbps Ethernet network. The LED indicator on the left bottom corner will flash on and off when Ethernet packets are being transmitted or received.

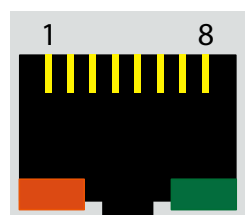

Location	10 Mbps	100 Mbps	1000 Mbps
Right Bottom LED	off	Solid Green	Solid Orange
Left Bottom LED	Flash Yellow	Flash Yellow	Flash Yellow

2.2.5 Dual Display Port

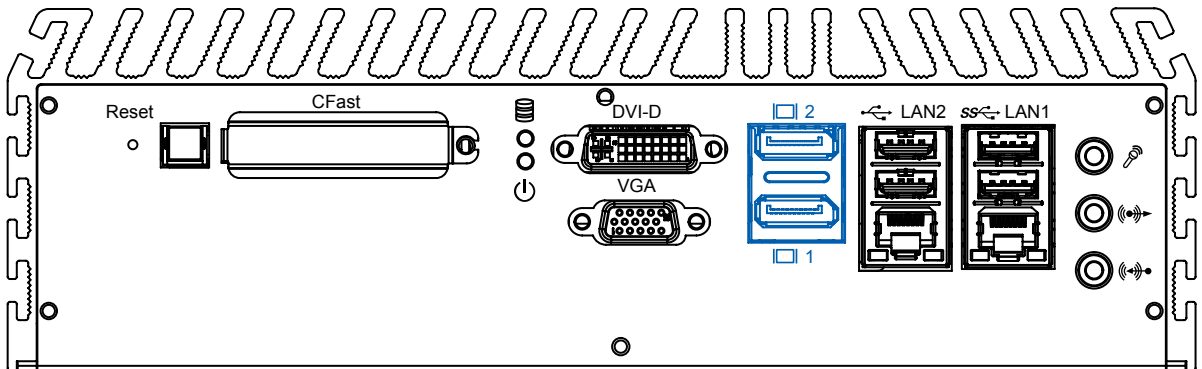

Each digital port is capable of driving resolutions up to 2560x1600 at 60 Hz through Display Port.

2.2.6 DVI-D/HDMI Connector

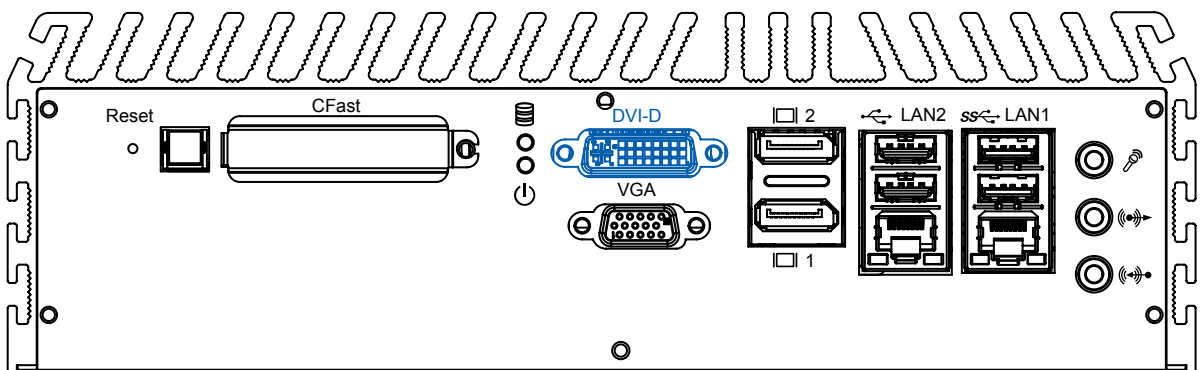

The DVI-D connector on the front panel supports both DVI and HDMI operation mode. This connector can either output DVI signals or HDMI signal. The DVI output mode supports up to 1920x1200 resolutions and HDMI output mode supports up to 1920x1200 resolutions. The DVI or HDMI mode is automatically selected according to the display device connected. You shall need a DVI-D to HDMI cable when connecting to a HDMI display device.

2.2.7 VGA Connector

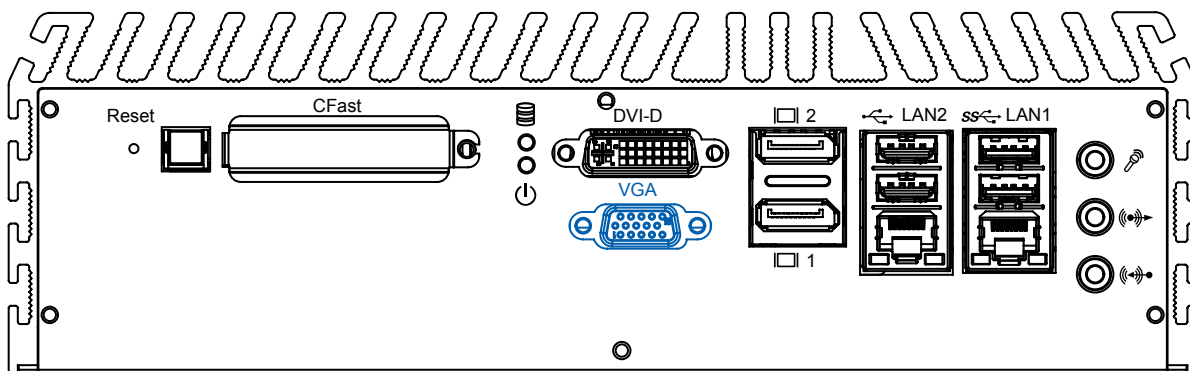

The Echo77F-PoER comes with a DB15 female connector on the front panel to connect a VGA monitor. To ensure that the monitor image remains clear, be sure to tighten the monitor cable after connecting it to the Echo77F-PoER. The VGA output mode supports up to 1920x1200 resolutions. The pin assignments of the VGA connector are shown below.

Pin No.	Description
1	Red Color Signal
2	Green Color Signal
3	Blue Color Signal
4	NC
5	Ground
6	VGA Detect
7	Ground
8	Ground
9	VCC
10	Ground
11	NC
12	DDC-DATA
13	H-Sync.
14	V-Sync.
15	DDC-CLK

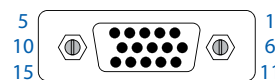

2.2.8 PWR and HDD LED Indicators

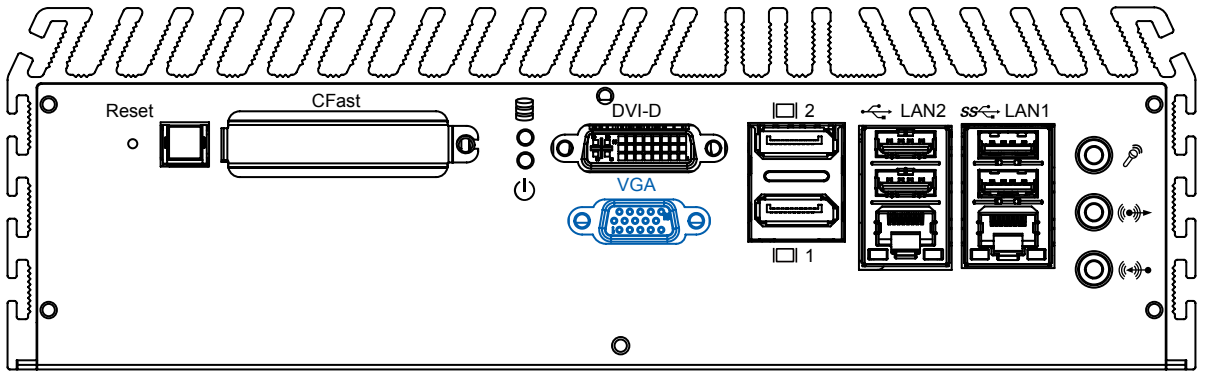

Yellow-HDD LED: A hard disk / CFast LED. If the LED is on, it indicates that the system's storage is functional. If it is off, it indicates that the system's storage is not functional. If it is flashing, it indicates data access activities.

Green-Power LED: If the LED is solid green, it indicates that the system is powered on.

2.2.9 CFast Card

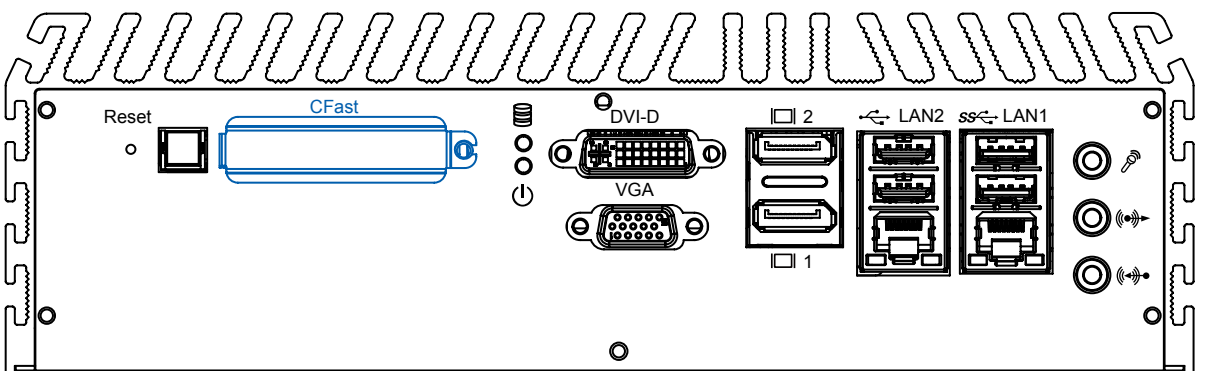

The Echo77F-PoER system comes with a CFast socket on the front panel for Type-I / Type-II Compact Flash card. It is implemented by a SATA II Port from QM77 PCH. Be sure to disconnect the power source and unscrew the CFast socket cover before installing a CFast card. The Echo77F-PoE does not support the CFast hot swap and PnP (Plug and Play) functions. It is necessary to remove power source first before inserting or removing the CFast card. The following table shows the pinouts for CFast port:

Pin No.	Description	Pin No.	Description	Pin No.	Description
S1	GND	PC2	GND	PC10	NC
S2	SATA_TX_P2	PC3	NC	PC11	NC
S3	SATA_TX_N2	PC4	NC	PC12	NC
S4	GND	PC5	NC	PC13	+3.3V
S5	SATA_RX_N2	PC6	NC	PC14	+3.3V
S6	SATA_RX_P2	PC7	GND	PC15	GND
S7	GND	PC8	NC	PC16	GND
PC1	NC	PC9	CFAST_LED_N	PC17	NC

2.2.10 Power Button

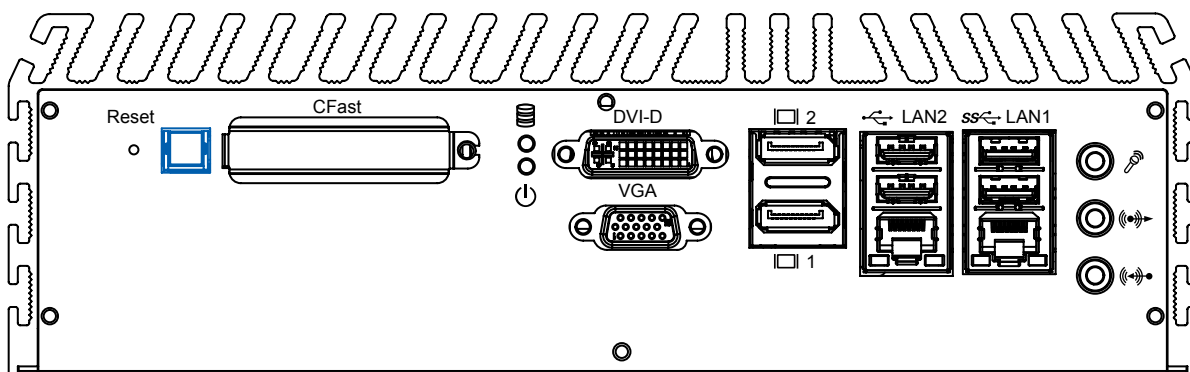

The power button is a non-latched switch with dual color LED (Blue/Orange) for indication S0, S3 and S5 status. Power button dual-color LED indicator:

Status	LED Display	System Situation
S0	Solid Blue	System working
S3, S5	Solid Orange	Suspend to RAM, System off with standby power

To turn on the Echo77F-PoER, press the power button and the blue LED is lighted up. To turn off the Echo77F-PoER, you can either issue a shutdown command in OS, or just simply press the power button.

In case of system halts, you can press and hold the power button for 4 seconds to compulsorily shut down the system. Please note that a 4 seconds interval is kept by the system between two on/off operations (i.e. once turning off the system, you shall wait for 4 seconds to initiate another power-on operation).

2.2.11 Reset Tact Switch

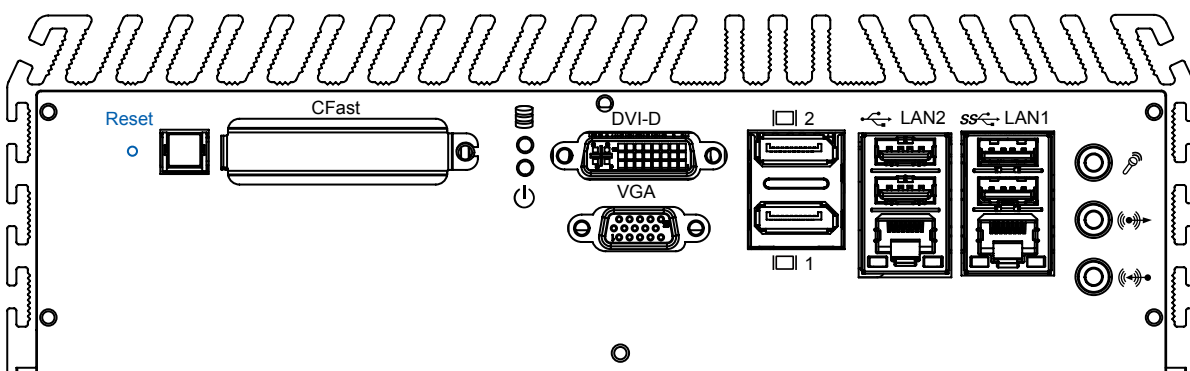

It is a hardware reset switch. Use this switch to reset the system without turning off the power. Momentarily pressing the switch will activate a reset.

2.3 Rear Panel I/O Functions

2.3.1 DC-In 6~36V Mini DIN or Power Terminal Block

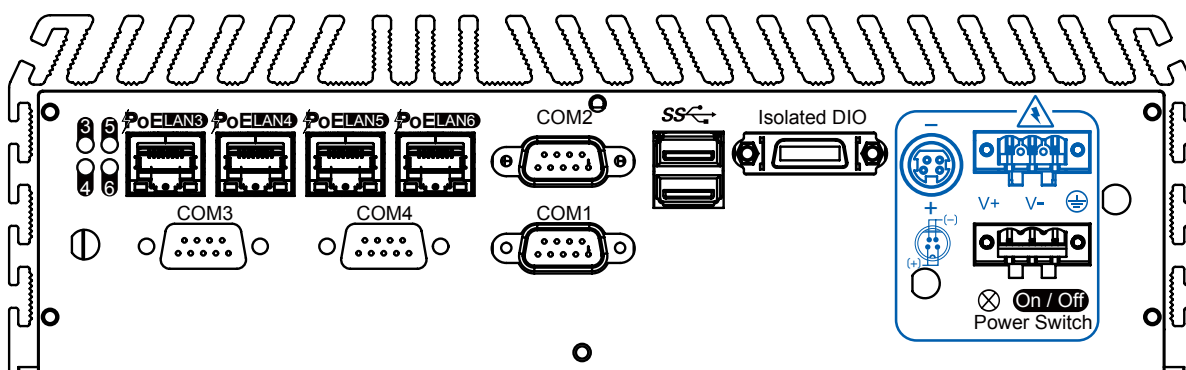

The Echo77F-PoER offers 6 to 36 VDC power input with the terminal block. If the power is supplied properly, the Power LED will light up a solid green.

80V power surge protection is design in in LTC4356. Grounding and write routing help limit the effects of noise due to EMI. Run the ground connection from the ground screw to the grounding surface prior to connecting the power.

See the figure shown below for the location of the earth ground on the terminal block power connector. Connect the earth ground wire to an appropriate grounded metal surface.

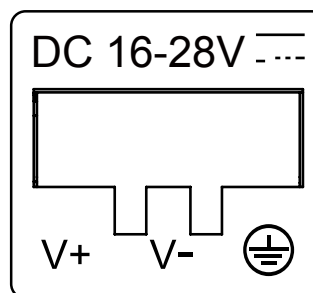

2.3.2 Remote Power On/Off Switch

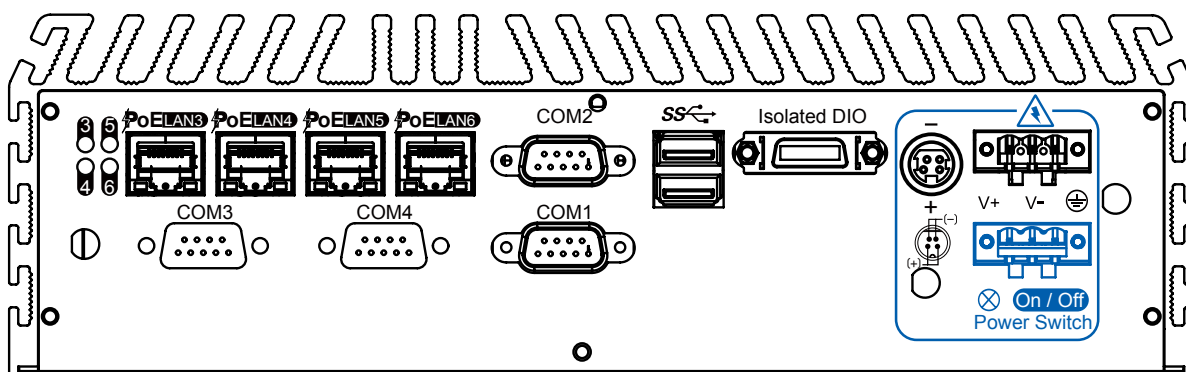

It is a 2-pin power-on or power-off switch through Phoenix Contact terminal block. You could turn on or off the system power by using this contact. This terminal block support dual function of soft power-on / power-off (instant off or delay 4 second), and suspend mode.

2.3.3 Isolated 8 DI / 8 DO

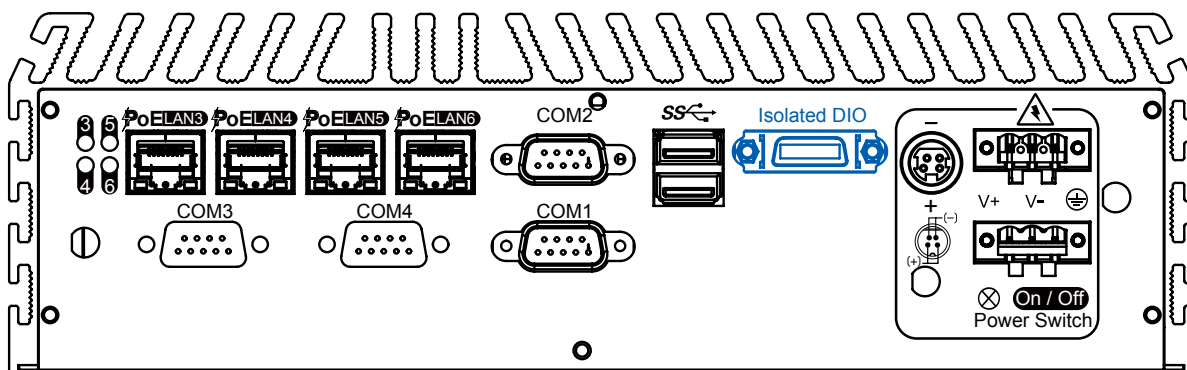

The Echo77F-PoER offers an 16-bit DIO (8-DI / 8-DO) connector. Each bit of DI and DO equipped with a photo-coupler for isolated protection. A power buffer device TPD2007F integrated in 8-DO circuit for motors, solenoids, and lamp drivers applications.

Pin No.	Definition	Mapping to SIO GPIO Function
1	INPUT0	SIO_GPI50
2	INPUT 1	SIO_GPI51
3	INPUT 2	SIO_GPI52
4	INPUT 3	SIO_GPI53
5	INPUT 4	SIO_GPI54
6	INPUT 5	SIO_GPI55
7	INPUT 6	SIO_GPI56
8	INPUT 7	SIO_GPI57
9	DI_COM	
10	GND	
11	OUTPUT0	SIO_GPO20
12	OUTPUT 1	SIO_GPO21
13	OUTPUT 2	SIO_GPO22
14	OUTPUT 3	SIO_GPO23
15	OUTPUT 4	SIO_GPO24
16	OUTPUT 5	SIO_GPO25
17	OUTPUT 6	SIO_GPO26
18	OUTPUT 7	SIO_GPO27
19	N.C.	
20	External 24VDC Input	

GPI SINK Mode

Isolated GPI input circuit in SINK mode (NPN) is illustrated as follows.

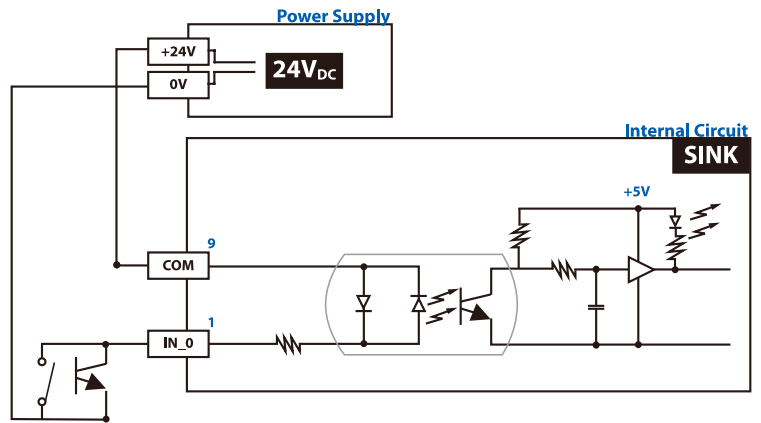

GPI SOURCE Mode

Digital GPI input signal circuit in SOURCE mode (PNP) is illustrated as follows:

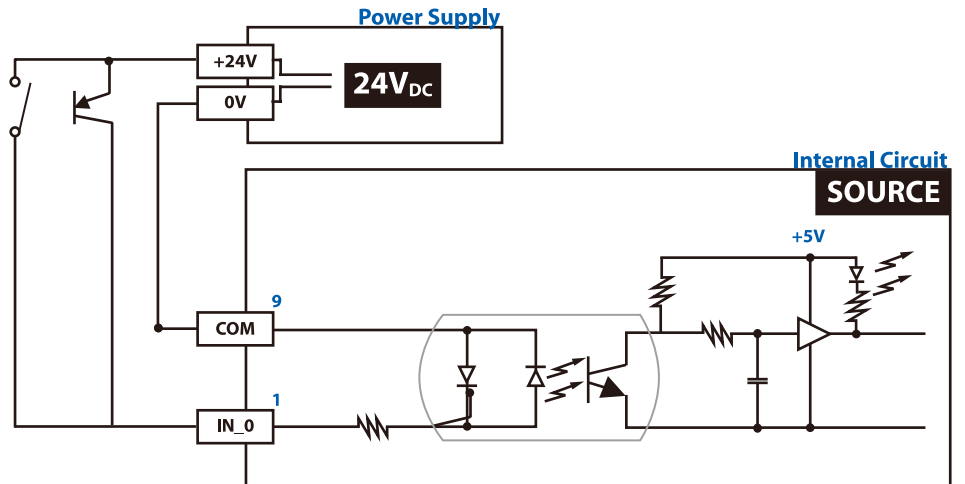

GPO SINK Mode:

Digital GPO output circuit in SINK mode (NPN) is illustrated below.

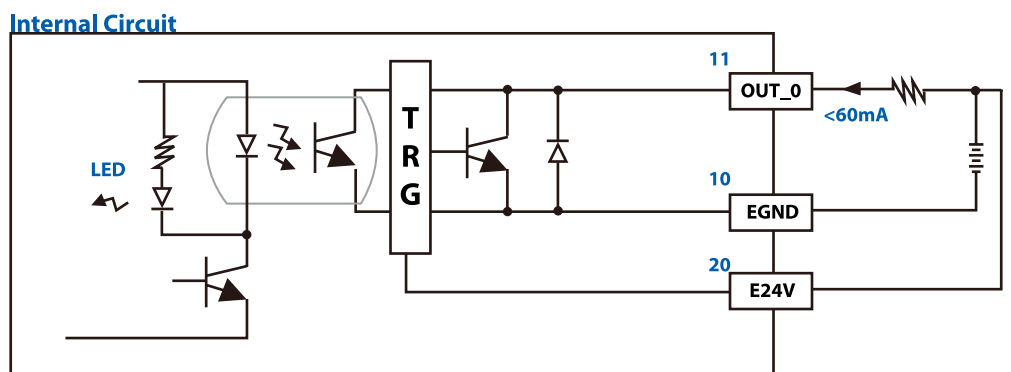

2.3.4 Serial Port COM2

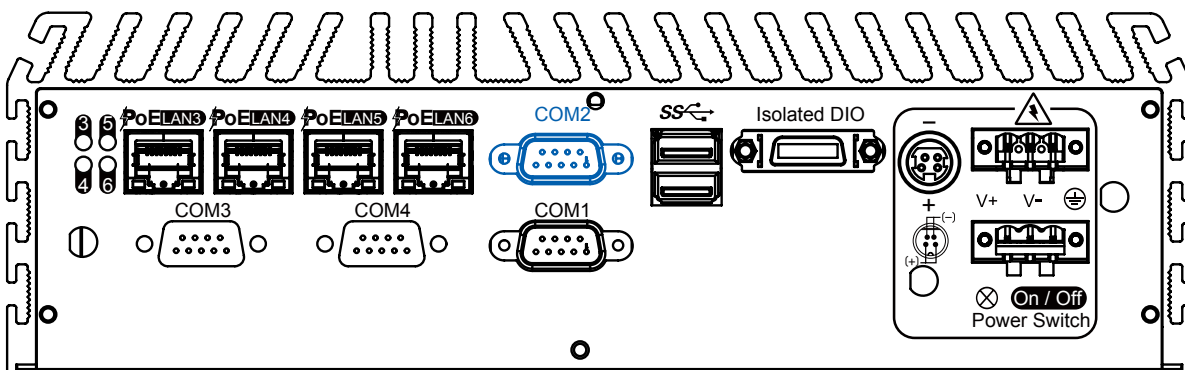

Serial port 2 can be configured for RS-232, RS-422, or RS-485 with auto flow control communication. Serial Port 2 default setting is RS-232, if you want to use RS-422 or RS-485, you can find the setting in BIOS.

BIOS Setting	Function
COM2	RS-232
	RS-422 (5-wire)
	RS-422 (9-wire)
	RS-485
	RS-485 w/z auto-flow control

The pin assignments are shown in the following table:

Serial Port	Pin No.	RS-232	RS-422 (5-Wire)	RS-422 (9-Wire)	RS-485 (3-Wire)
2	1	DCD	TXD-	TXD-	DATA-
	2	RXD	TXD+	TXD+	DATA+
	3	TXD	RXD+	RXD+	-----
	4	DTR	RXD-	RXD-	-----
	5	GND	GND	GND	GND
	6	DSR	-----	RTS-	-----
	7	RTS	-----	RTS+	-----
	8	CTS	-----	CTS+	-----
	9	RI	-----	CTS-	-----

2.3.5 Serial Port COM1/COM3 / COM4

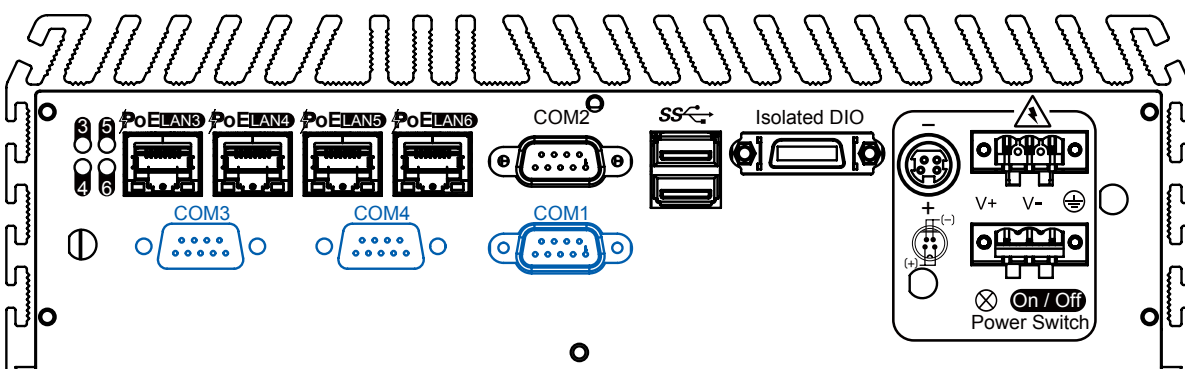

COM1, COM3 and COM4 are RS-232 only and provide up to 115200 bps baud rates. The pin assignments are shown in the following table:

BIOS Setting	Pin No.	Function
COM1, 3, 4	1	DCD
	2	RXD
	3	TXD
	4	DTR
	5	GND
	6	DSR
	7	RTS
	8	CTS
	9	RI

2.3.6 PoE, Power over Ethernet Ports

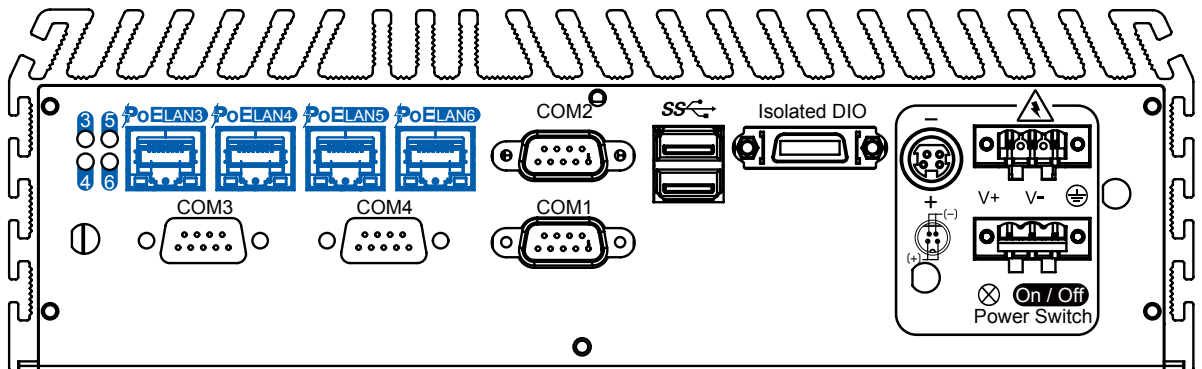

Echo77F-PoER equipped with 4 IEEE 802.3at PoE+ ports for transmitting power as much as 25.5W / 48V per port and 1000BASE-T gigabit data signals over standard Ethernet CAT-5/CAT-6 cable.

Every PoE port applies one Intel® 82574L Gigabit Ethernet controller and independent PCI express interface to connect with multi-core processor for network and data transmit optimization.

Only when PoE port starts to supply power to power devices , the dedicated LED will be light on.

2.4 Main Board Expansion Connectors

The figure below is the top view of the Echo77F-PoER main board. It shows the location of the connectors.

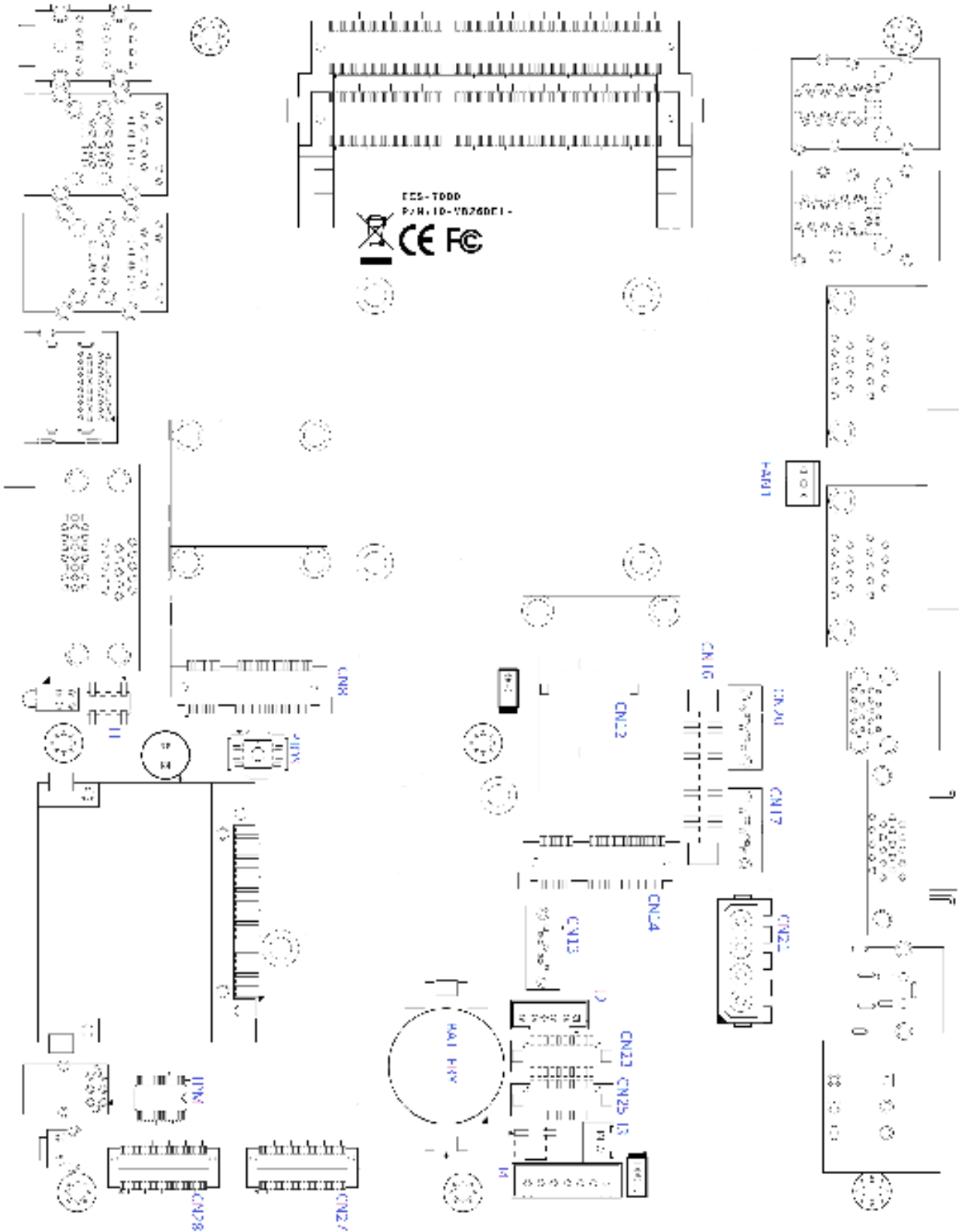
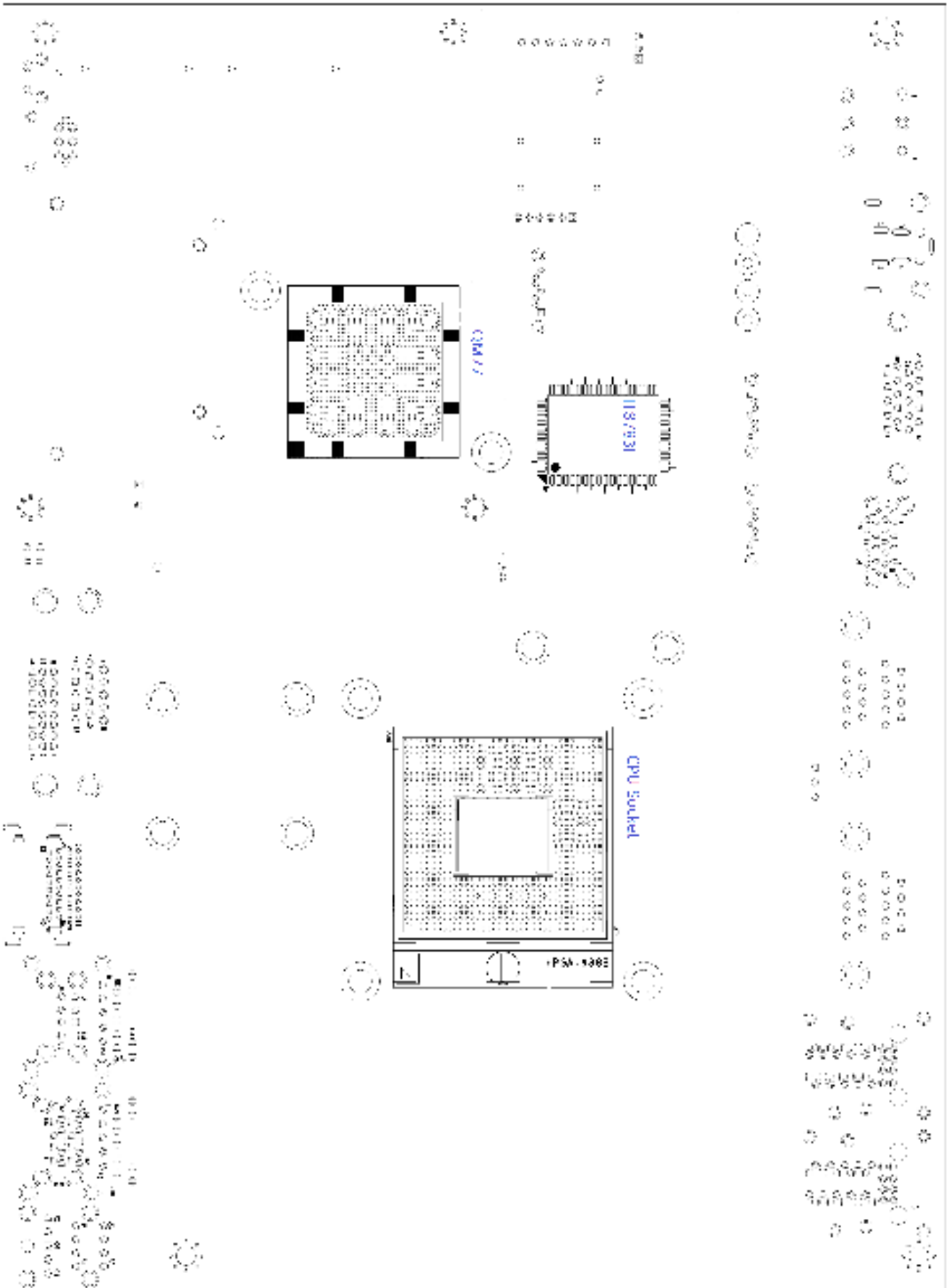
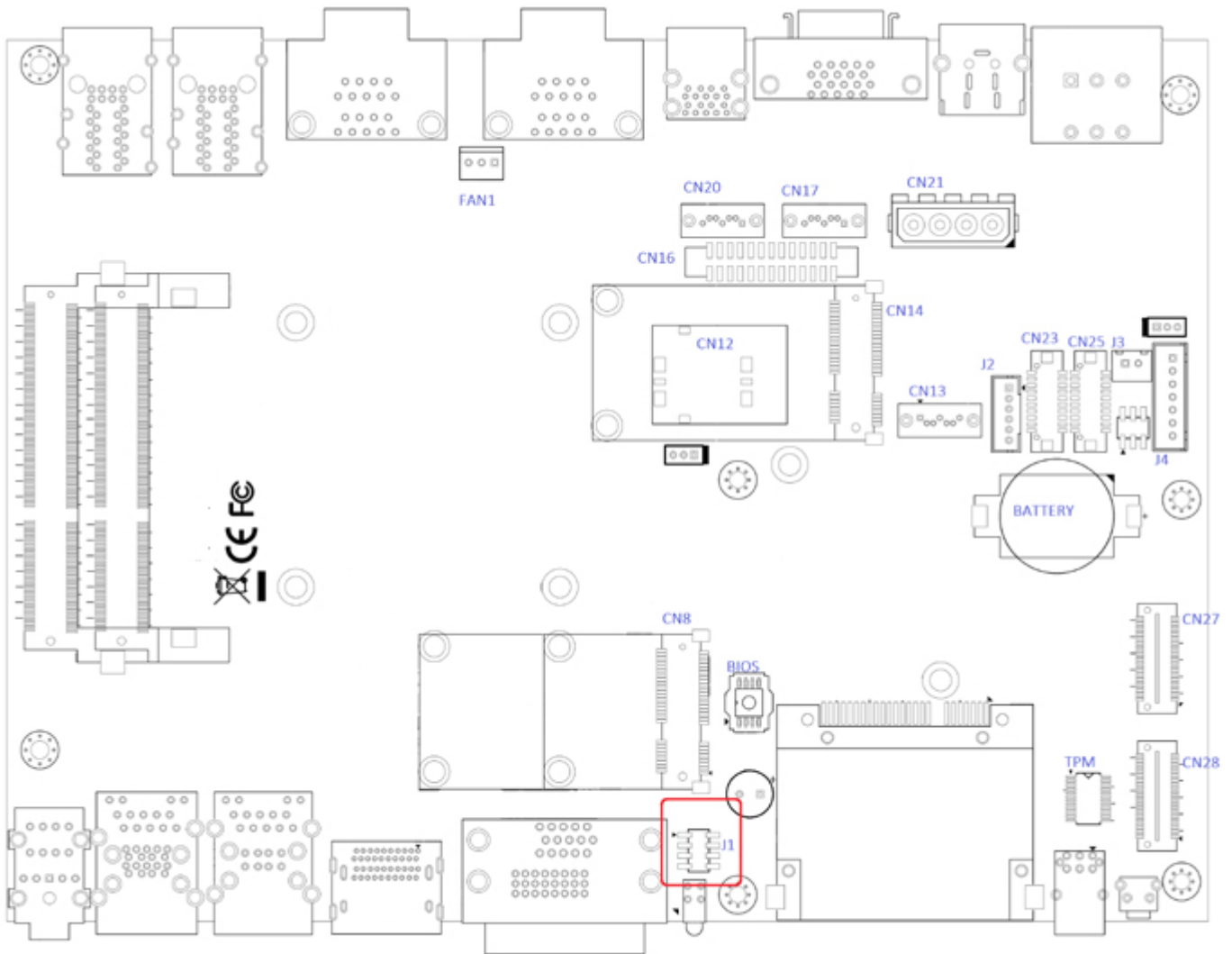

Figure 2.3.1 Internal Connectors and Jumpers

The figure below is the bottom view of the Echo77F-PoER main board.



2.4.1 J1 Miscellaneous Pin Header



These pin headers can be used as a backup for the following functions: hard drive LED indicator, reset button, power LED indicator, and power-on/off button. The front and top panel already provides access to these functions. The following table shows the pinouts for Miscellaneous port:

J1 Miscellaneous Pin Header

Group	Pin No.	Description
HDD LED	1	HDLED
	3	HD_LED_N
Reset Button	5	FP_RST_BTN_N
	7	GND
Power LED	2	PWRLED
	4	PWROK_100MS_N
Power Button	6	FP_PWR_BTN_N
	8	GND

2.4.2 CN23, CN25, J4 LVDS

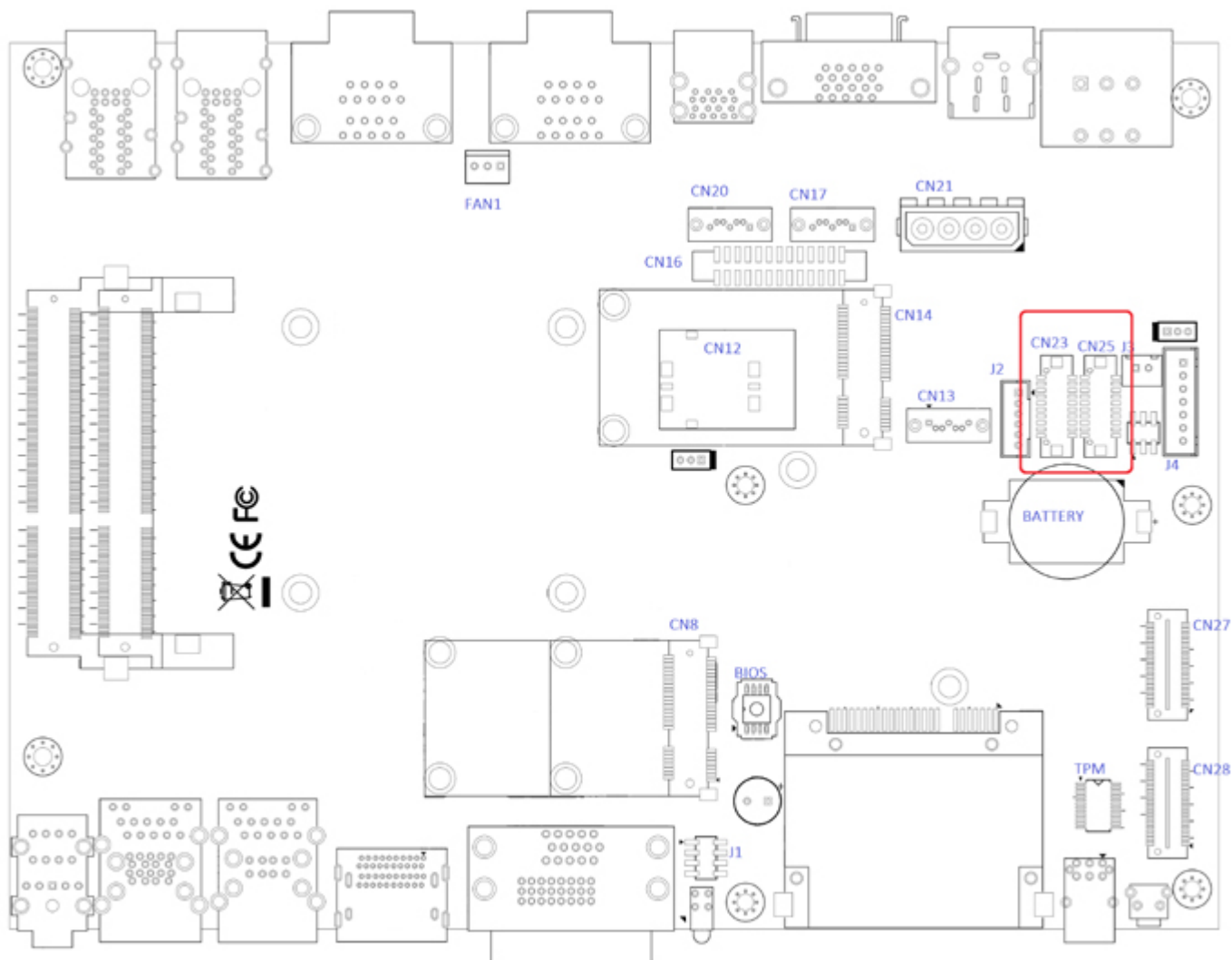

The Echo77F-PoER supports dual-channel 24-bit LVDS panel up to 1366x768 pixels resolution.

Pin No.	Definition	
	CN23 Channel A	CN25 Channel B
1	LDDC_CLK	LDDC_CLK
2	LDDC_DATA	LDDC_DATA
3	PANEL_VDD (+3.3V or +5V by jumper)	PANEL_VDD (+3.3V or +5V by jumper)
4	LA_DATA0_P	LB_DATA0_P
5	LA_DATA3_P	LB_DATA3_P
6	LA_DATA0_N	LB_DATA0_N
7	LA_DATA3_N	LB_DATA3_N
8	PANEL_VDD (+3.3V or +5V by jumper)	PANEL_VDD (+3.3V or +5V by jumper)
9	GND	GND
10	LA_DATA1_P	LB_DATA1_P
11	LA_CLKP	LB_CLKP
12	LA_DATA1_N	LB_DATA1_N
13	LA_CLKN	LB_CLKN

Pin No.	Definition	
	CN23 Channel A	CN25 Channel B
14	GND	GND
15	GND	GND
16	PANEL_BACKLIGHT (+12V)	PANEL_BACKLIGHT (+12V)
17	LA_DATA2_P	LB_DATA2_P
18	PANEL_BACKLIGHT (+12V)	PANEL_BACKLIGHT (+12V)
19	LA_DATA2_N	LB_DATA2_N
20	GND	GND

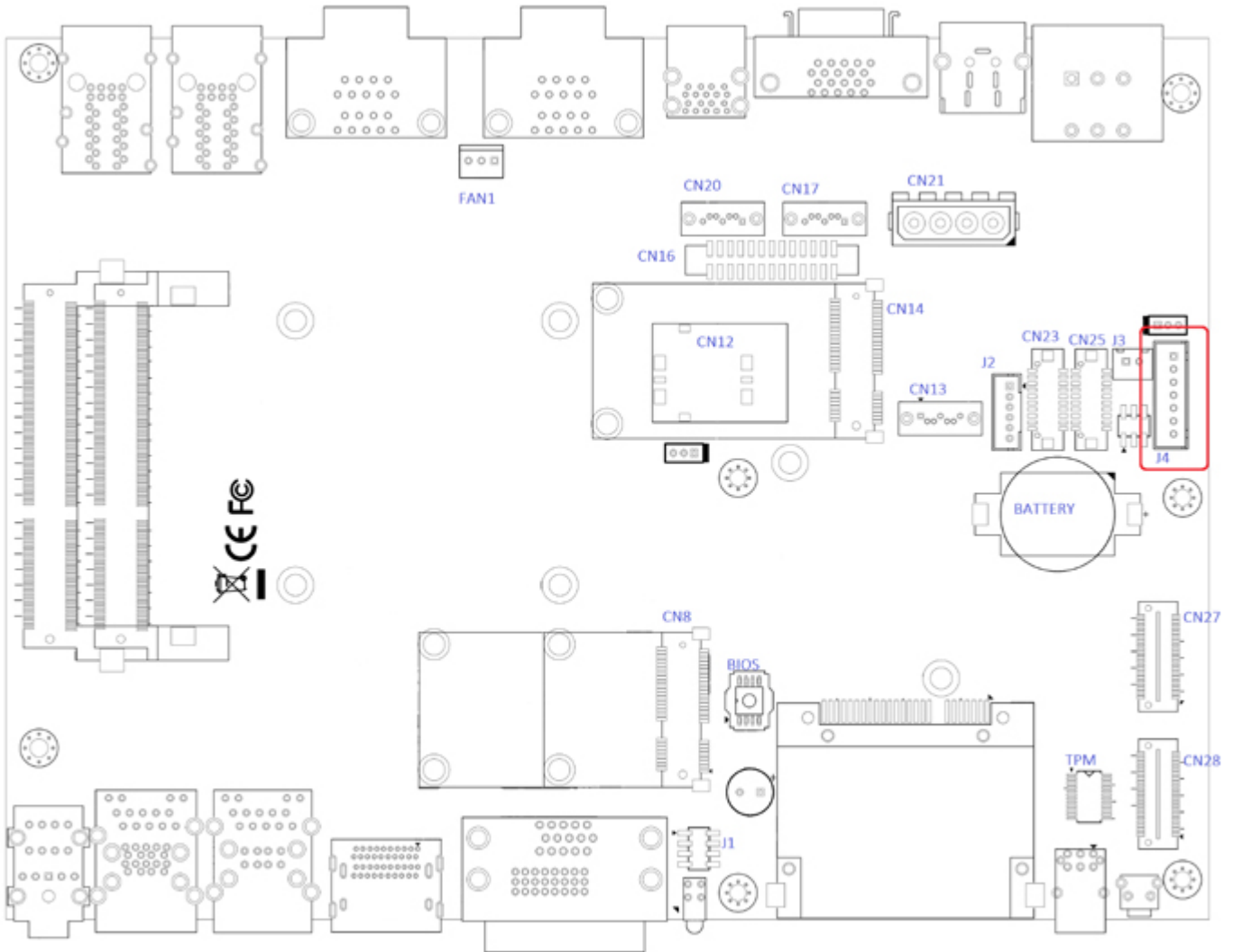

The LCD inverter is connected to J4 via a JST 7-pin, 2.5mm connector to provide +5V/+12V power to the LCD display.

Pin No.	Definition
1	+5V
2	+12V
3	+12V
4	LBKLT_CTL
5	GND
6	GND
7	LBKLT_EN

2.4.3 CN17, CN20 SATA3 & CN21 SATA Power Connector

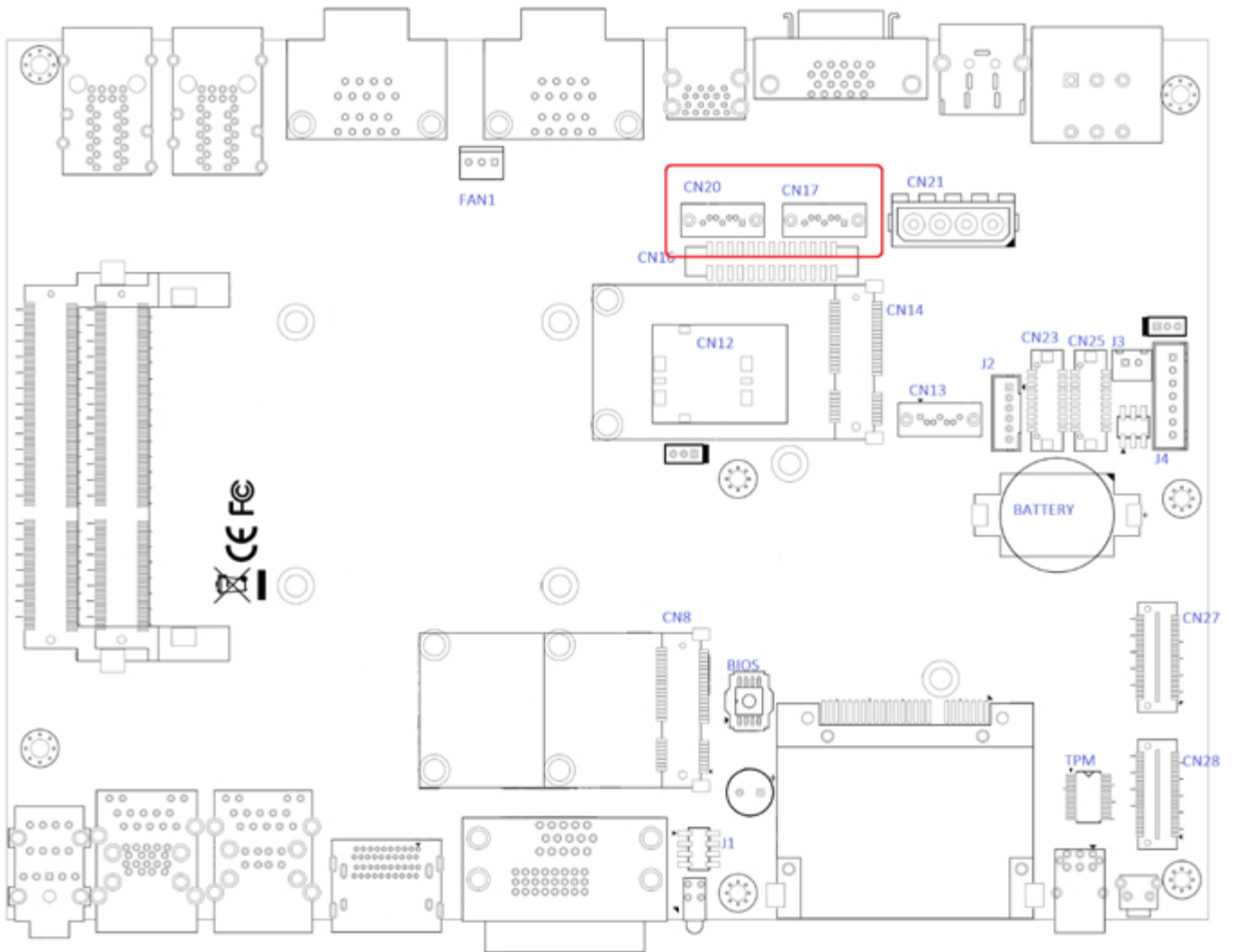

The Echo77F-PoER features 2 high performance Serial ATA III interfaces that ease cabling to hard drives or SSD with thin and short cables while application need larger storage capacity.

Pin No.	Definition
1	GND
2	TXP
3	TXN
4	GND
5	RXN
6	RXP
7	GND

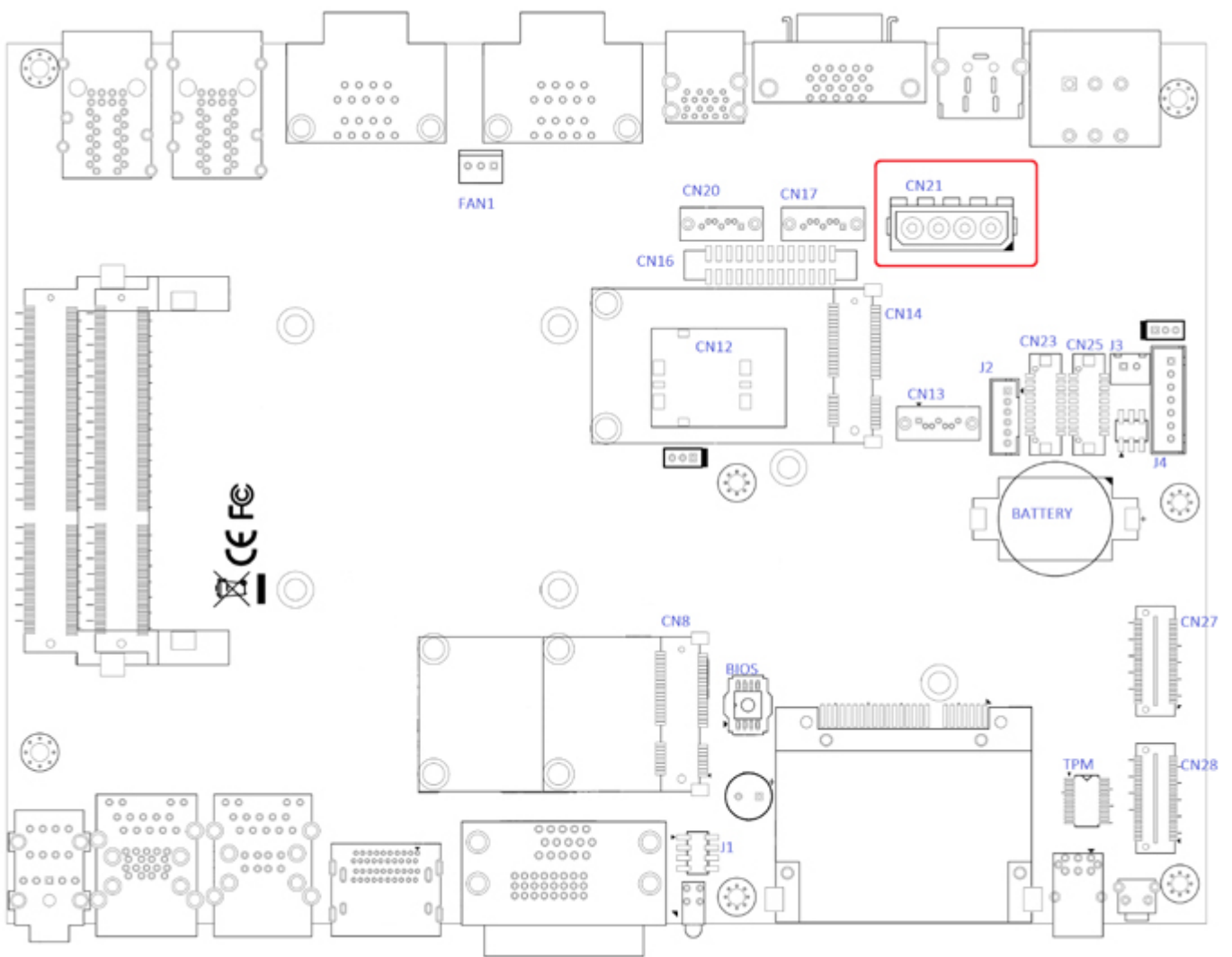

The Echo77F-PoER is also equipped one SATA power connector. It supplies 5V (2A max.) and 12V (1A max) current to the hard drive or SSD.

CN21 SATA HDD Power Connections

Pin No.	Definition
1	+12V
2	GND
3	GND
4	+5V

2.4.4 CN13 SATA-II Connector J3 SATA DOM Power Connector

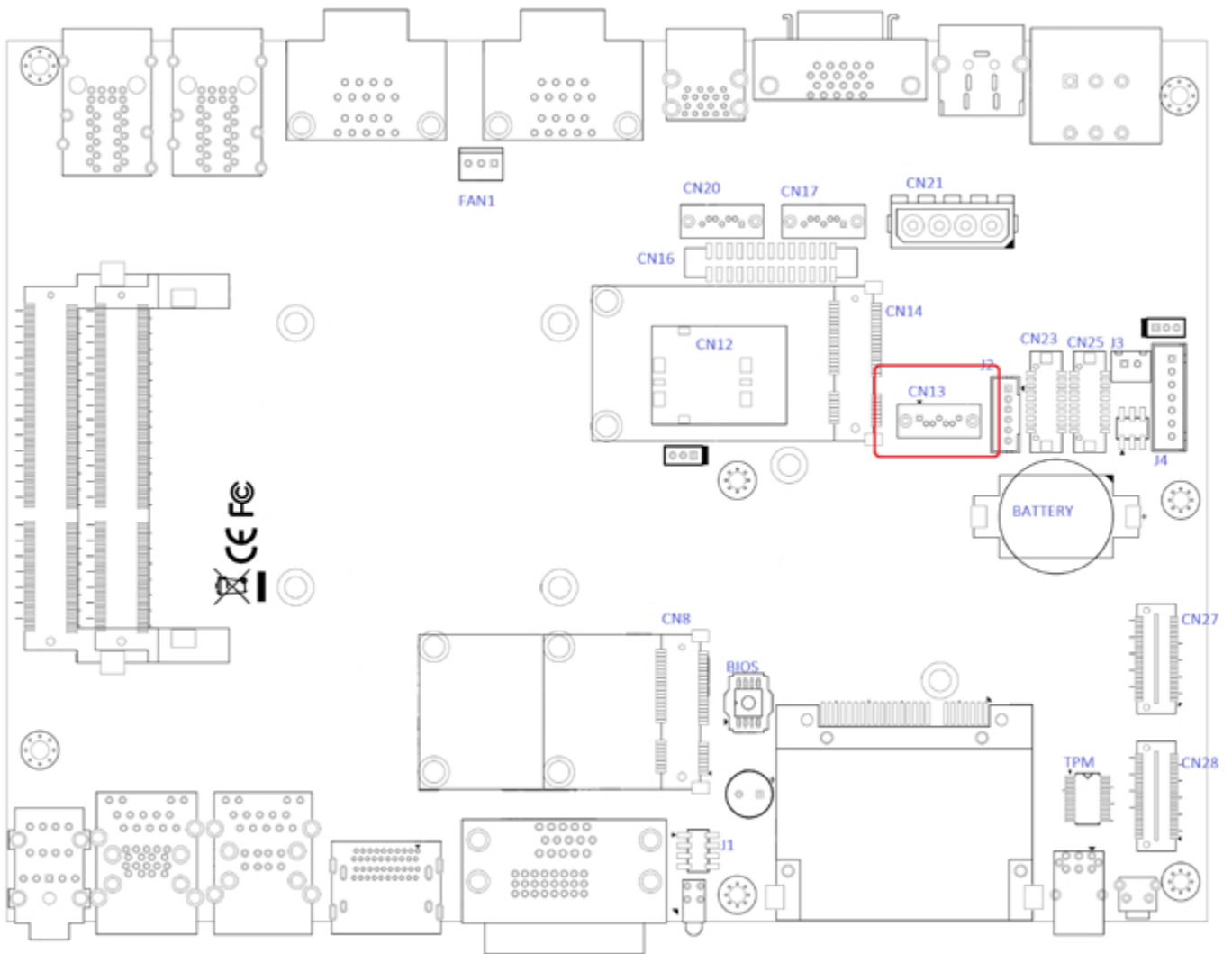

The Echo77F-PoER features one SATA-II interface while applications need SATA DOM.

Pin No.	Definition
1	GND
2	TXP
3	TXN
4	GND
5	RXN
6	RXP
7	GND

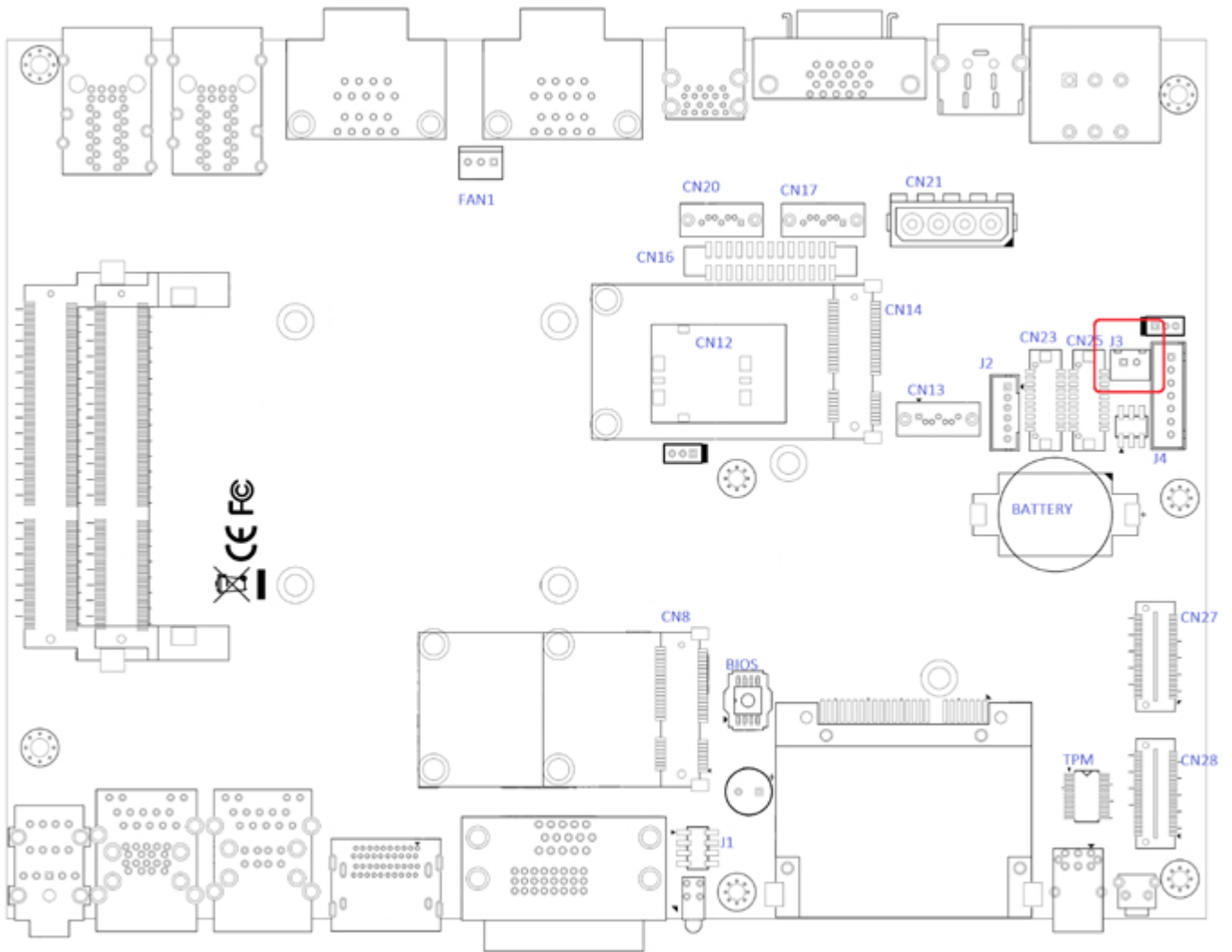

The Echo77F-PoER is also equipped one SATA DOM power connector. It supplies 5V (0.5A max.) current to the SATA DOM.

J3 SATA DOM Power Connections

Pin No.	Definition
1	+5V
2	GND

2.4.5 J2 Internal USB Dual Port

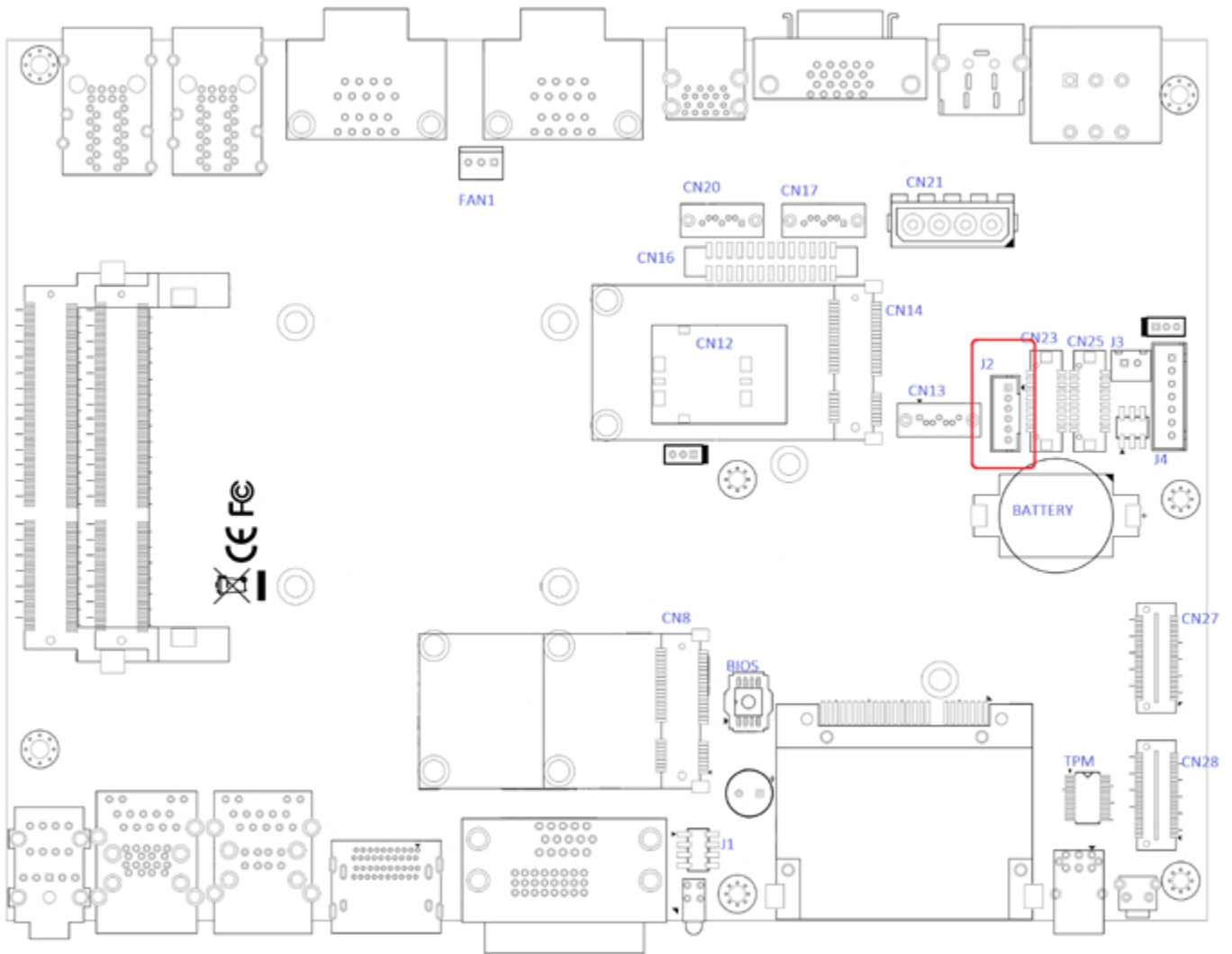

The Echo77F-PoER's main board provides up to two USB plug-and-play ports for Dongle Key or LCD touch Panel using. The USB interface supports 480 Mbps transfer rate which complies with high speed USB specification Rev. 2.0, and fuse protection. The USB interface is accessed through one 1x6-pin JST 2.0mm connector. You will need an adapter cable if you use a standard USB connector. The adapter cable has a 1x6-pin connector on one end and a USB connector on the other.

Pin No.	Definition	Pin No.	Definition
1	USB_VCC	2	USB2-
3	USB2+	4	USB3-
5	USB3+	6	GND

2.4.6 CN8, CN14 Mini-PCIe, mSATA Connectors

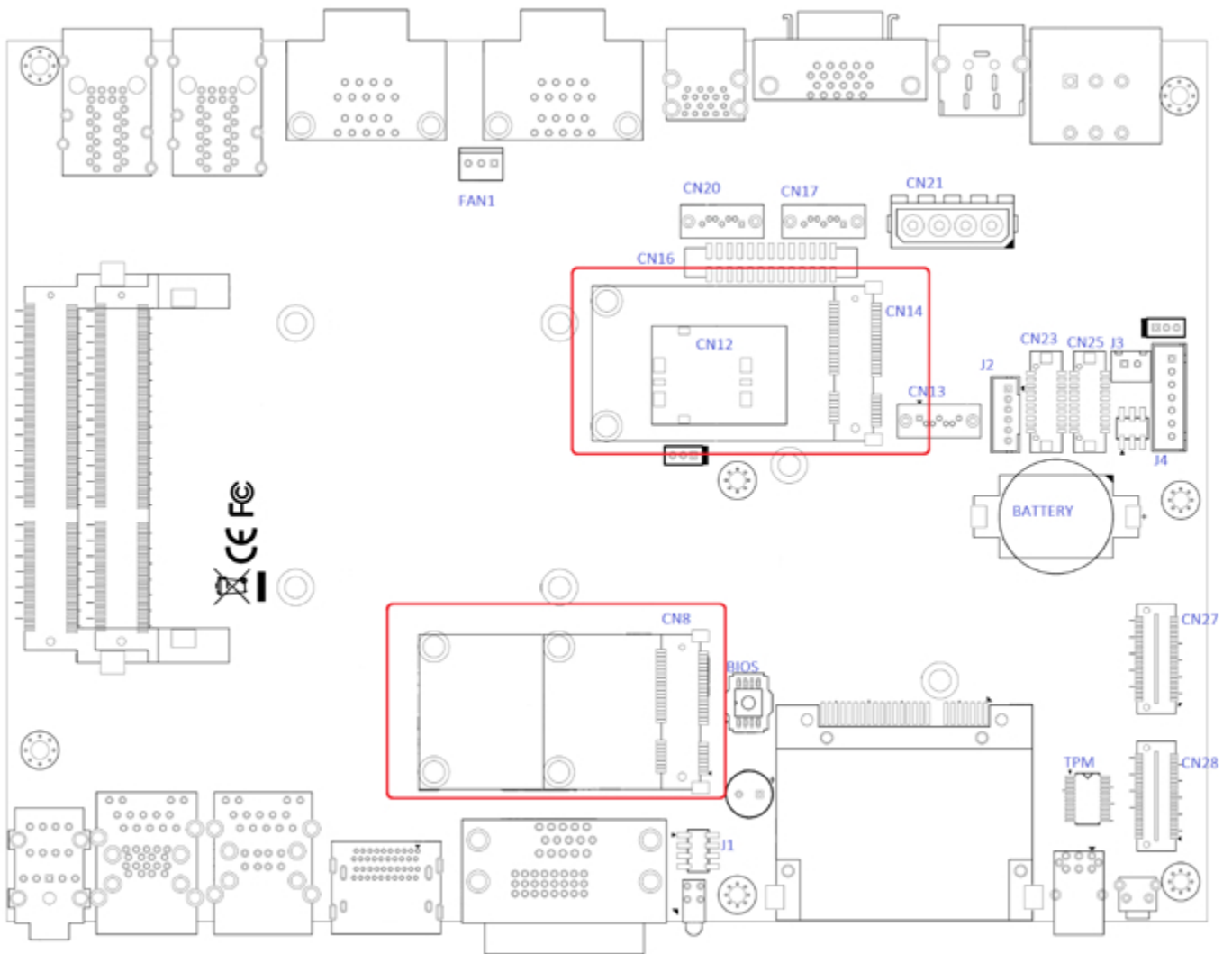

Both mSATA and Mini PCI-E share the same form-factor and similar electrical pinout assignments on their connectors. There was no clear mechanism to distinguish if a mSATA drive or a Mini PCI-E device is plugged into the socket until recently that SATA-IO issued an ECN change (ECN #045) to re-define pin 43 on mSATA connector as “no connect” instead of “return current path” (or GND).

When an mSATA drive is inserted, its pin 43 is “no connect”, and the respective pin on the socket is being pulled-up to logic 1. When a Mini PCI-E device is inserted, its pin 43 forces the respective pin on the socket to ground, or logic 0.

Echo77F-PoER is using Pin 43 status designed for switching between mSATA drive and mini PCI-e device.

Status	Mini PCI-e card	mSATA drive
Pin 43	Logic 0	Logic 1

CN8 Mini-PCIe Connector Pin Out

Pin No.	Signal Name	Pin No.	Signal Name	Pin No.	Signal Name	Pin No.	Signal Name
51	Reserved	52	+3.3Vaux	33	PETp0	34	GND
49	Reserved	50	GND	31	PETn0	32	SMB_DATA
47	Reserved	48	+1.5V	29	GND	30	SMB_CLK
45	Reserved	46	Reserved	27	GND	28	+1.5V
43	Status	44	Reserved	25	PERp0	26	GND
41	+3.3Vaux	42	Reserved	23	PERn0	24	+3.3Vaux
39	+3.3Vaux	40	GND	21	GND	22	PERST#
37	GND	38	USB_D+	19	Reserved	20	reserved
35	GND	36	USB_D-	17	Reserved	18	GND
Mechanical Key							
15	GND	16	Reserved	7	CLKREQ#	8	Reserved
13	REFCLK+	14	Reserved	5	Reserved	6	1.5V
11	REFCLK-	12	Reserved	3	Reserved	4	GND
9	GND	10	Reserved	1	WAKE#	2	3.3Vaux

CN14 Mini-PCIe Connector Pin Out

Pin No.	Signal Name	Pin No.	Signal Name	Pin No.	Signal Name	Pin No.	Signal Name
51	Reserved	52	+3.3Vaux	33	PETp0	34	GND
49	Reserved	50	GND	31	PETn0	32	SMB_DATA
47	Reserved	48	+1.5V	29	GND	30	SMB_CLK
45	Reserved	46	Reserved	27	GND	28	+1.5V
43	Status	44	Reserved	25	PERp0	26	GND
41	+3.3Vaux	42	Reserved	23	PERn0	24	+3.3Vaux
39	+3.3Vaux	40	GND	21	GND	22	PERST#
37	GND	38	USB_D+	19	Reserved	20	reserved
35	GND	36	USB_D-	17	Reserved	18	GND
Mechanical Key							
15	GND	16	UIM_VPP	7	CLKREQ#	8	UIM_PWR
13	REFCLK+	14	UIM_RST	5	Reserved	6	1.5V
11	REFCLK-	12	UIM_CLK	3	Reserved	4	GND
9	GND	10	UIM_DATA	1	WAKE#	2	3.3Vaux

2.4.7 CN16 GPIO

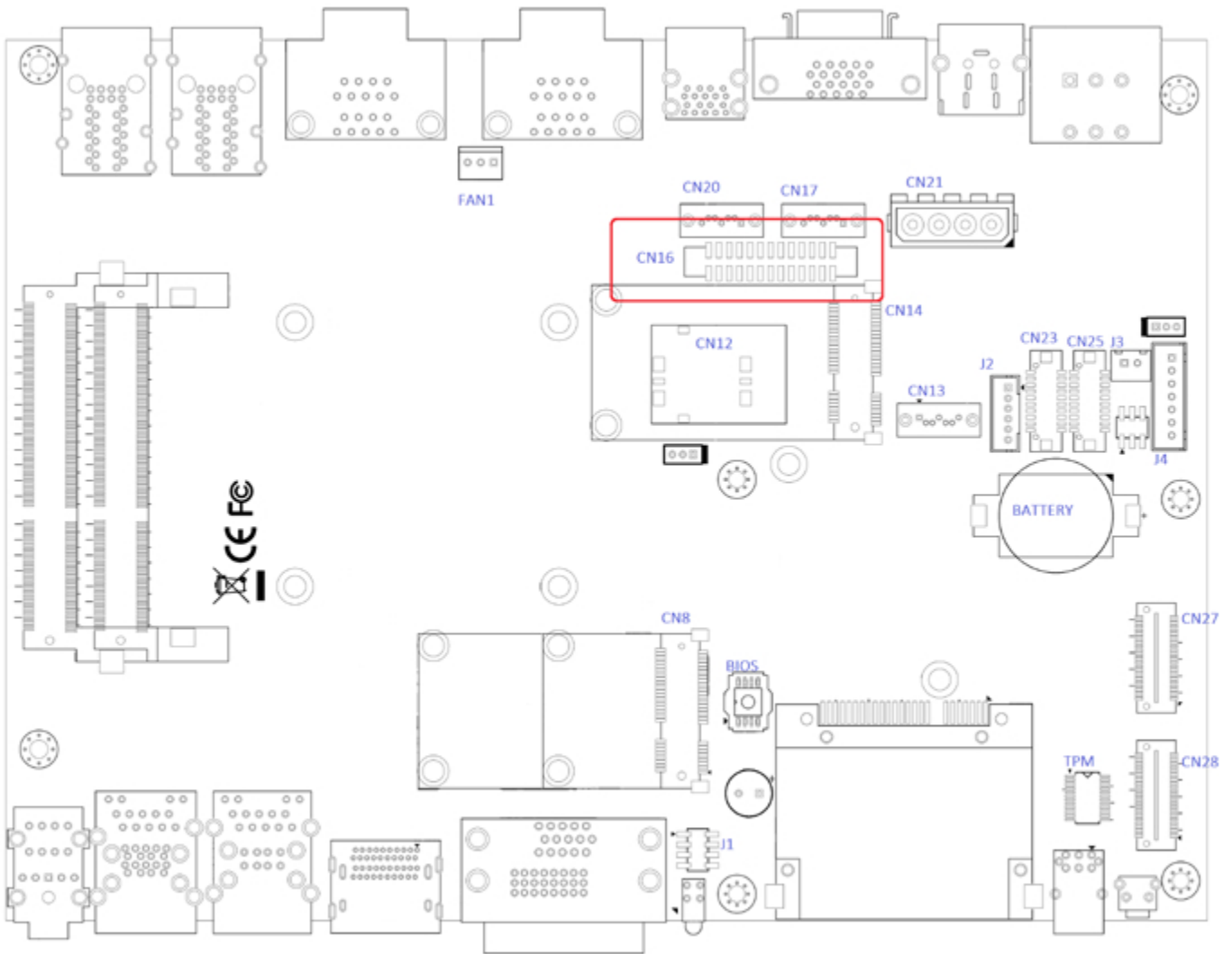

The Echo77F-PoER offers 16 programmable I/O within TTL 5V tolerance. If the GPIO is logic high, it indicates that the mapping SIO GPIO pin is logic high level. If the GPIO is logic low, it indicates that the mapping SIO GPIO pin is logic low level.

Pin No.	Description	Pin No.	Description
1	GND	14	GND
2	SIO_GP17	15	SIO_GP67
3	SIO_GP16	16	SIO_GP66
4	SIO_GP15	17	SIO_GP65
5	SIO_GP14	18	SIO_GP64
6	GND	19	GND
7	SIO_GP13	20	SIO_GP63
8	SIO_GP12	21	SIO_GP62
9	SIO_GP11	22	SIO_GP61
10	SIO_GP10	23	SIO_GP60
11	GND	24	GND
12	SMB_DATA	25	+5V
13	SMB_CLK	26	+5V

2.4.8 FAN1

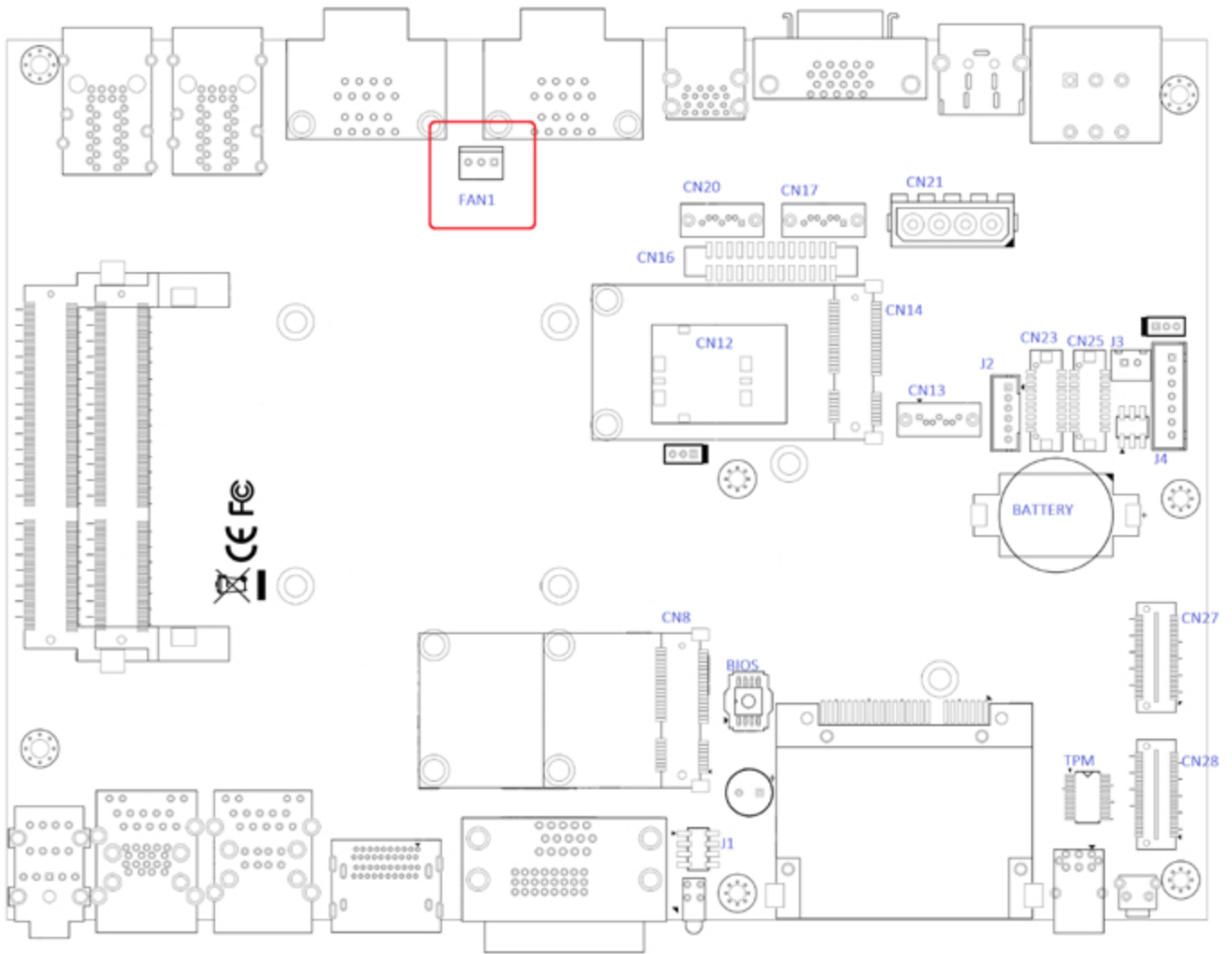

FAN power connector supports for higher thermal requirement.

Pin Out	Function
1	GND
2	+12V (1.5A max)
3	Fan-speed sense

2.4.9 CN27, CN28 SUMIT(Optional)

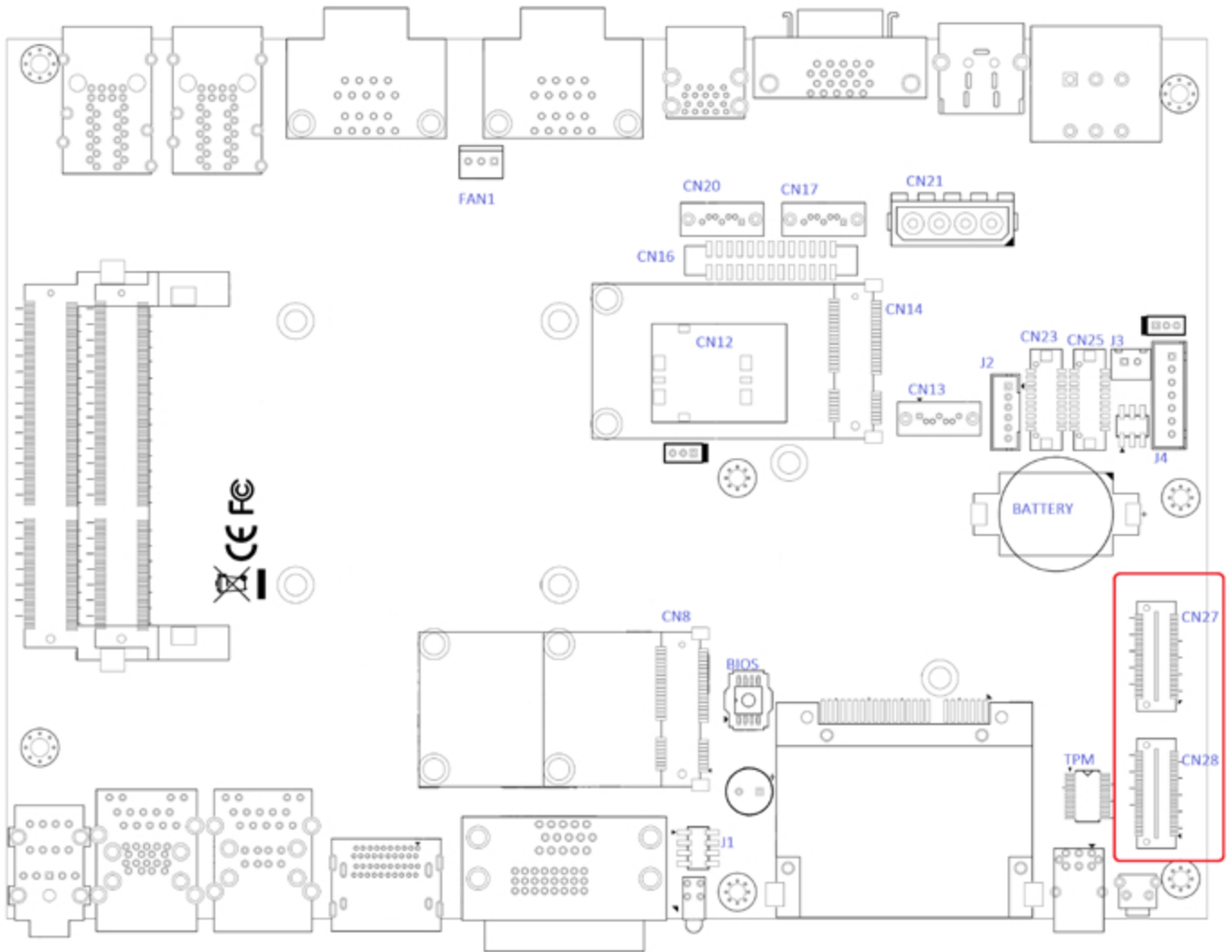

CN28 Pin out

Pin Out	Function	Pin Out	Function	Pin Out	Function	Pin Out	Function
1	+5V_AUX	2	+12V	27	+5V	28	LPC_AD2
3	+3.3V	4	SMB_DATA	29	USB_1+	30	LPC_AD3
5	+3.3V	6	XMB_CLK	31	USB_1-	32	LPC_FRAME#
7	Reserved	8	Reserved	33	+5V	34	SERIRQ#
9	Reserved	10	SPI_MISO	35	USB_0+	36	Reserved
11	USB_OC#	12	SPI_MOSI	37	USB_0-	38	CLK_33MHz
13	Reserved	14	SPI_CLK	39	GND	40	GND
15	+5V	16	SPI_CS10	41	A_PET_P0	42	A_PER_P0
17	USB_3+	18	SPI_CS1#	43	A_PET_N0	44	A_PER_N0
19	USB_3-	20	Reserved	45	GND	46	APRSNT#/A_PE_CLKREQ#
21	+5V	22	LPC_DRQ1#	47	PERST#	48	A_CLKP
23	USB_2+	24	LPC_AD0	49	WAKE#	50	A_CLKN
25	USB_2-	26	LPC_AD1	51	+5V	52	GND

CN27 Pin Out

Pin Out	Function	Pin Out	Function	Pin Out	Function	Pin Out	Function
1	GND	2	GND	27	C_PET_P2	28	C_PER_P2
3	B_PET_P0	4	B_PER_P0	29	C_PET_N2	30	C_PER_N2
5	B_PET_N0	6	B_PER_N0	31	GND	32	GND
7	GND	8	GND	33	C_PET_P3	34	C_PER_P3
9	C_CLKP	10	B_CLKP	35	C_PET_N3	36	C_PER_N3
11	C_CLKN	12	B_CLKN	37	GND	38	GND
13	CPRSNT#/C_PE_CLKREQ#	14	GND	39	PERST#	40	WAKE#
15	C_PET_P0	16	C_PER_P0	41	Reserved	42	Reserved
17	C_PET_N0	18	C_PER_N0	43	+5V	44	Reserved
19	GND	20	GND	45	+5V	46	+3.3V
21	C_PET_P1	22	C_PER_P1	47	+5V	48	+3.3V
23	C_PET_N1	24	C_PER_N1	49	+5V	50	+3.3V
25	GND	26	GND	51	+5V	52	+5V_AUX

2.4.10 Battery

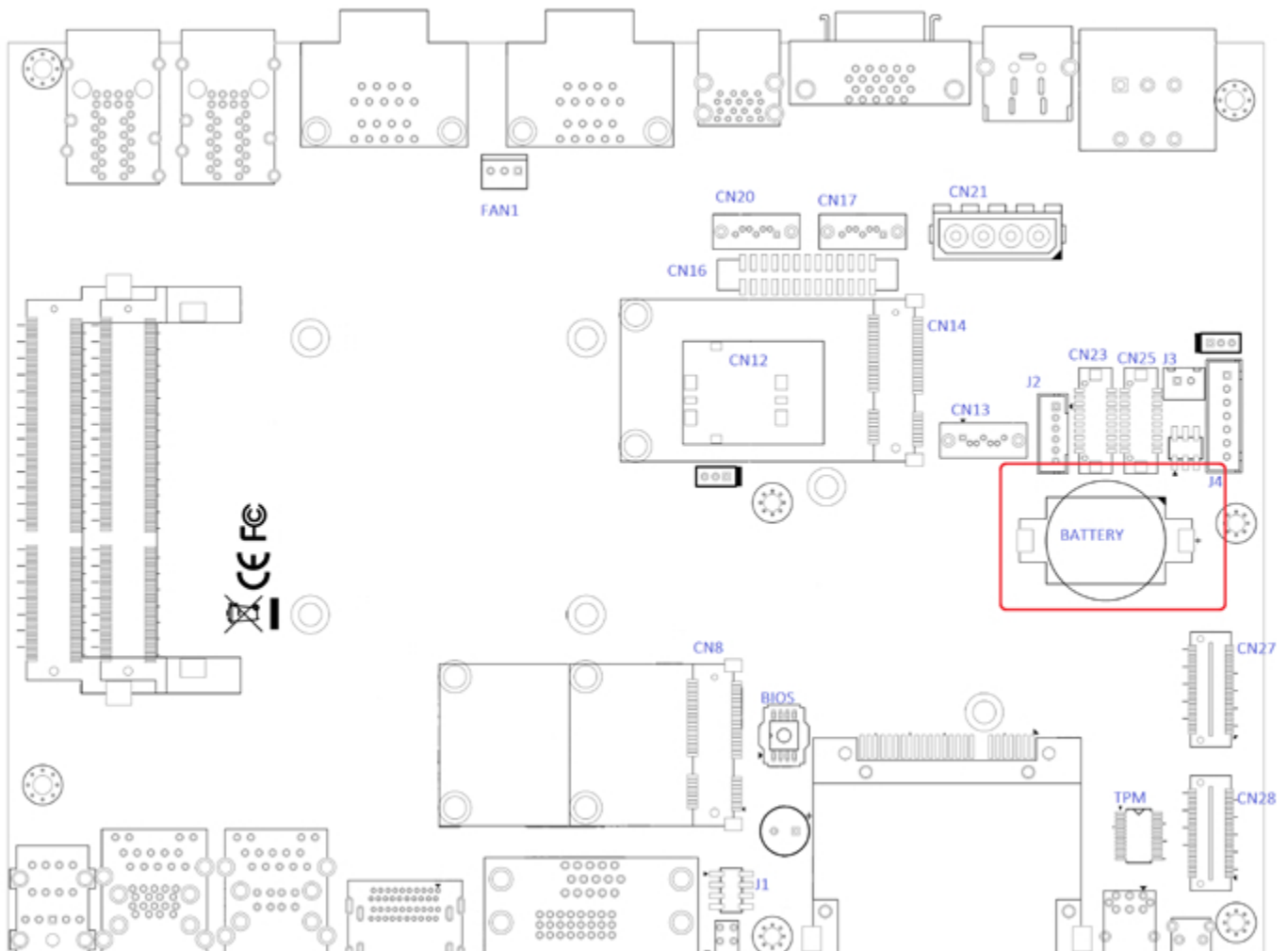

The Echo77F-PoER's real-time clock is powered by a lithium battery. The battery is Panasonic BR2032 190mAh lithium battery. Replacing the lithium battery on your own is **NOT** recommended. If the battery needs to be changed, please contact with the Unicom RMA service team.

2.5 Main Board Jumper Setting

The figure below is the top view of the Echo77F-PoER main board which is the main board used in the Echo77F-PoER system. It shows the location of the jumpers.

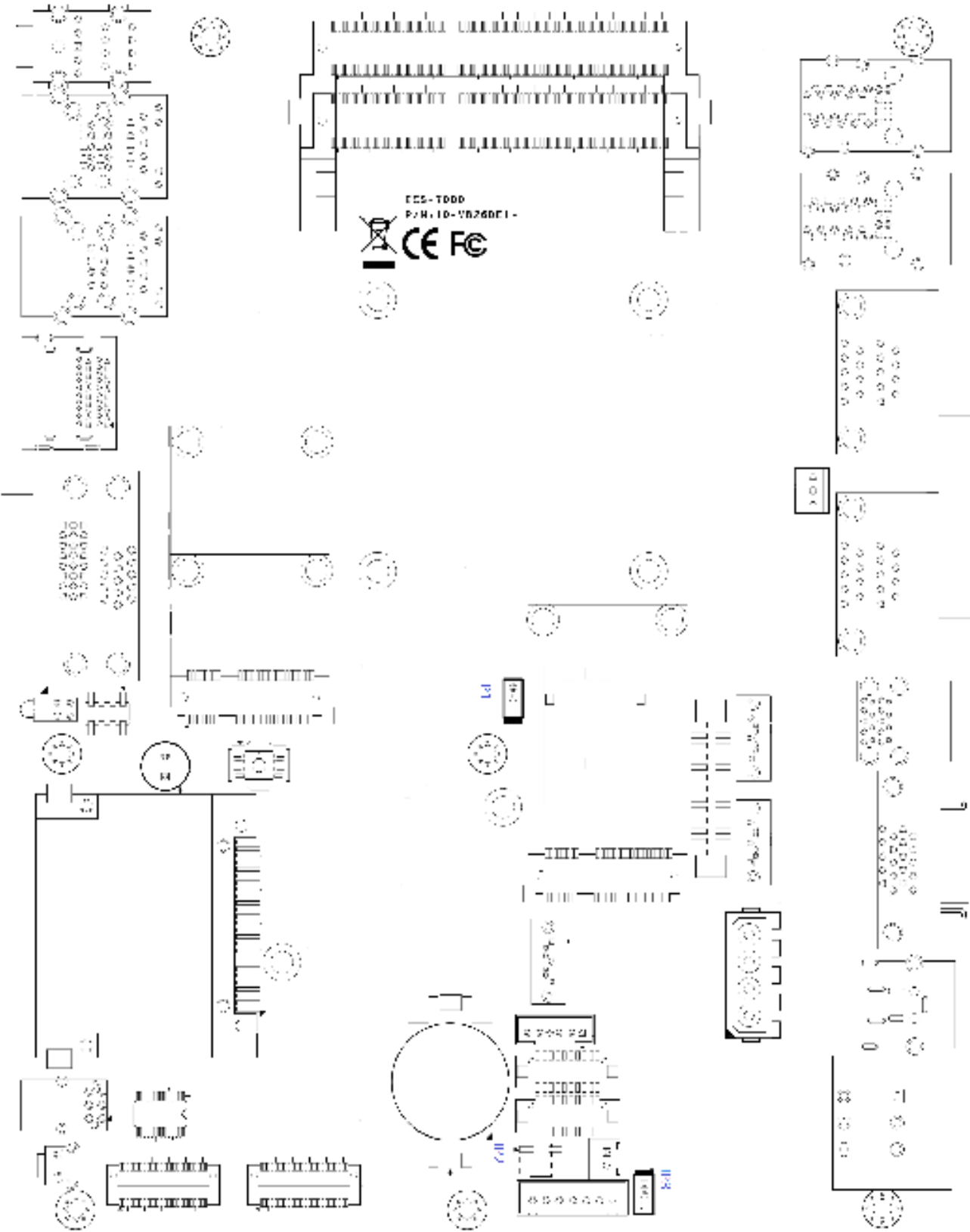

You may configure your card to match the needs of your application by setting jumpers. A jumper is a metal bridge used to close an electric circuit. It consists of two metal pins and a small metal clip (often protected by a plastic cover) that slides over the pins to connect them. To “close” a jumper, you connect the pins with the clip. To “open” a jumper, you remove the clip. Sometimes a jumper will have three pins, labeled 1, 2 and 3. In this case you would connect either pins 1 and 2, or 2 and 3.

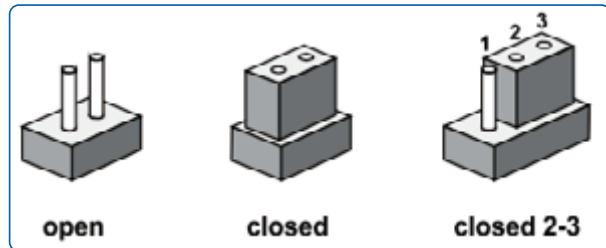

2.5.1 JP3 LVDS Backlight Power Selection

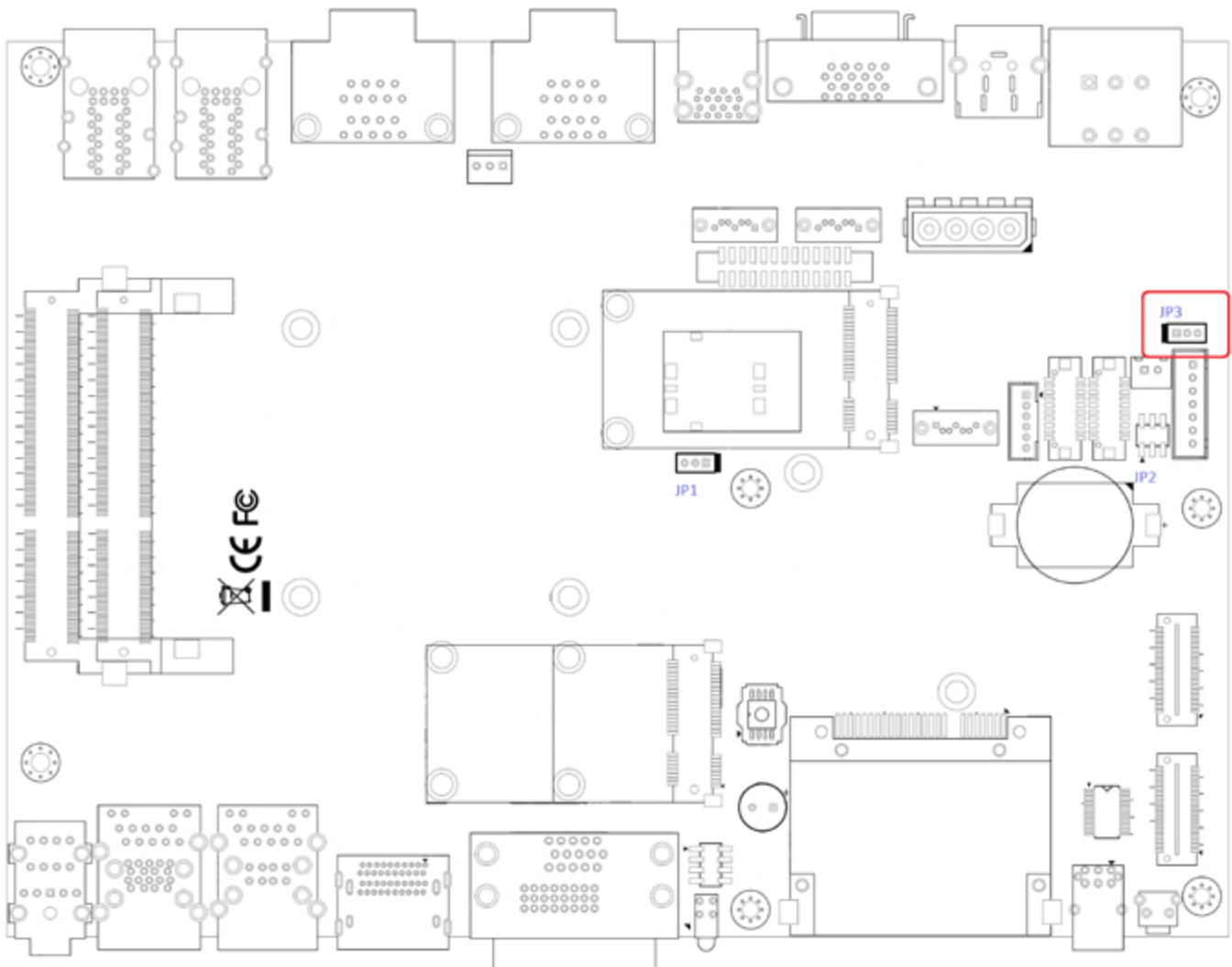

JP1 provides LVDS voltage selection function, closing Pin 1, 2 is for 3.3V LVDS power input; closing Pin 2, 3 is for 5V LVDS power input.

Setting	Description
1-2	+3.3V (Default)
2-3	+5V

2.5.2 JP2(A) CMOS Clear Jumper Setting

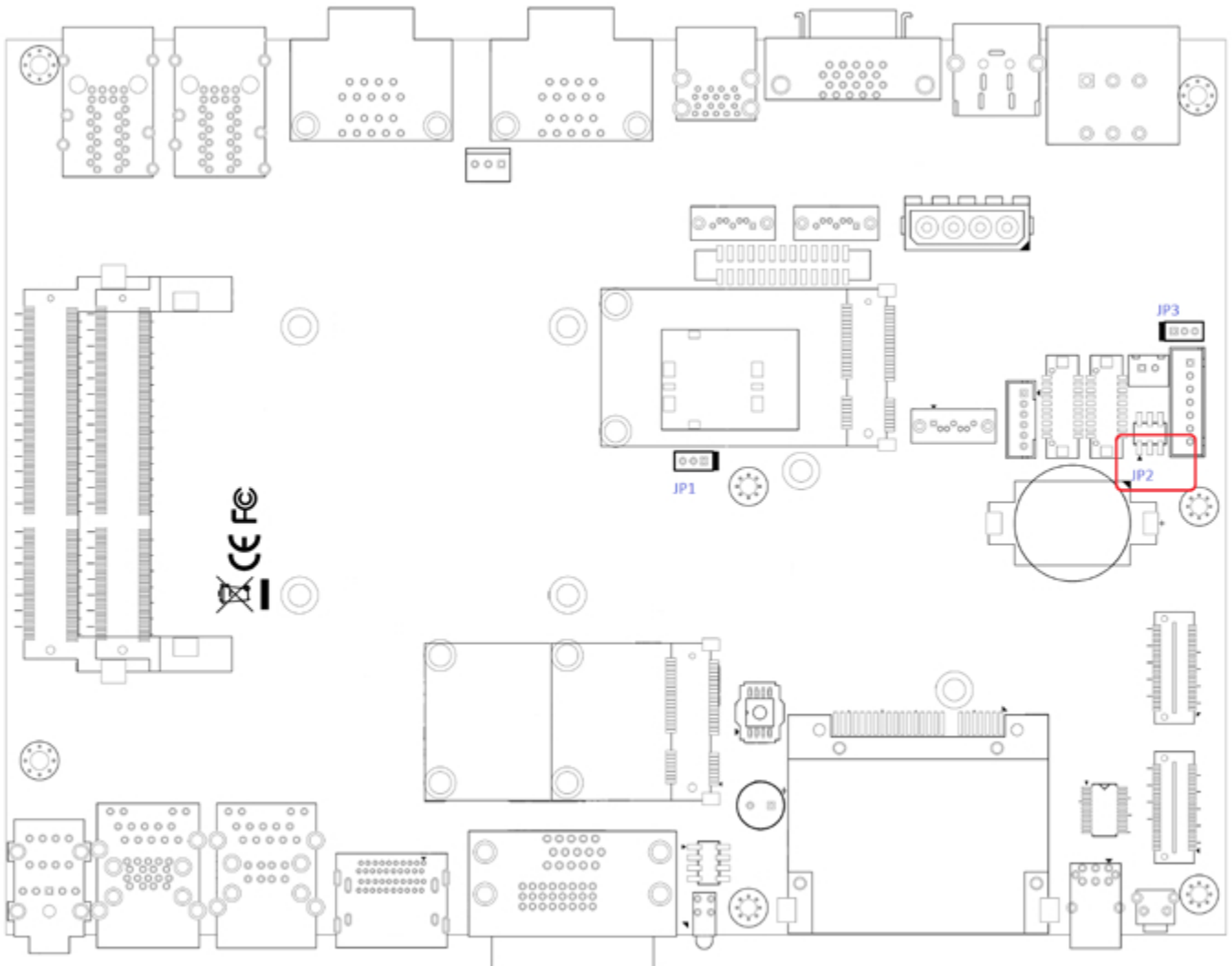

Setting	Description
1-3	Normal (Default)
3-5	Clear CMOS

2.5.3 JP2(B) ME Clear Jumper Setting

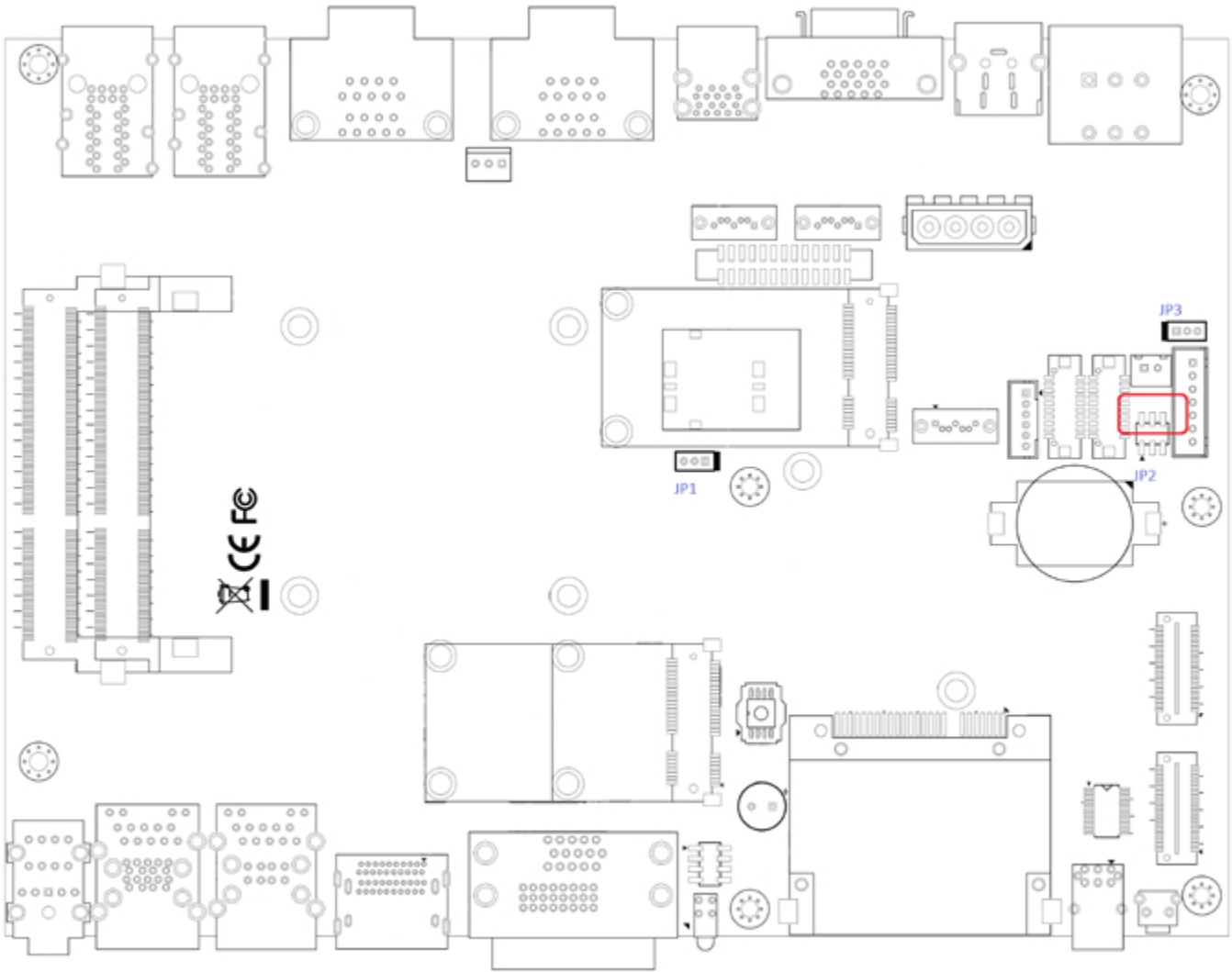

Setting	Description
2-4	Normal (Default)
4-6	Clear ME

2.5.4 JP1 AT/ATX Power Mode Jumper Setting

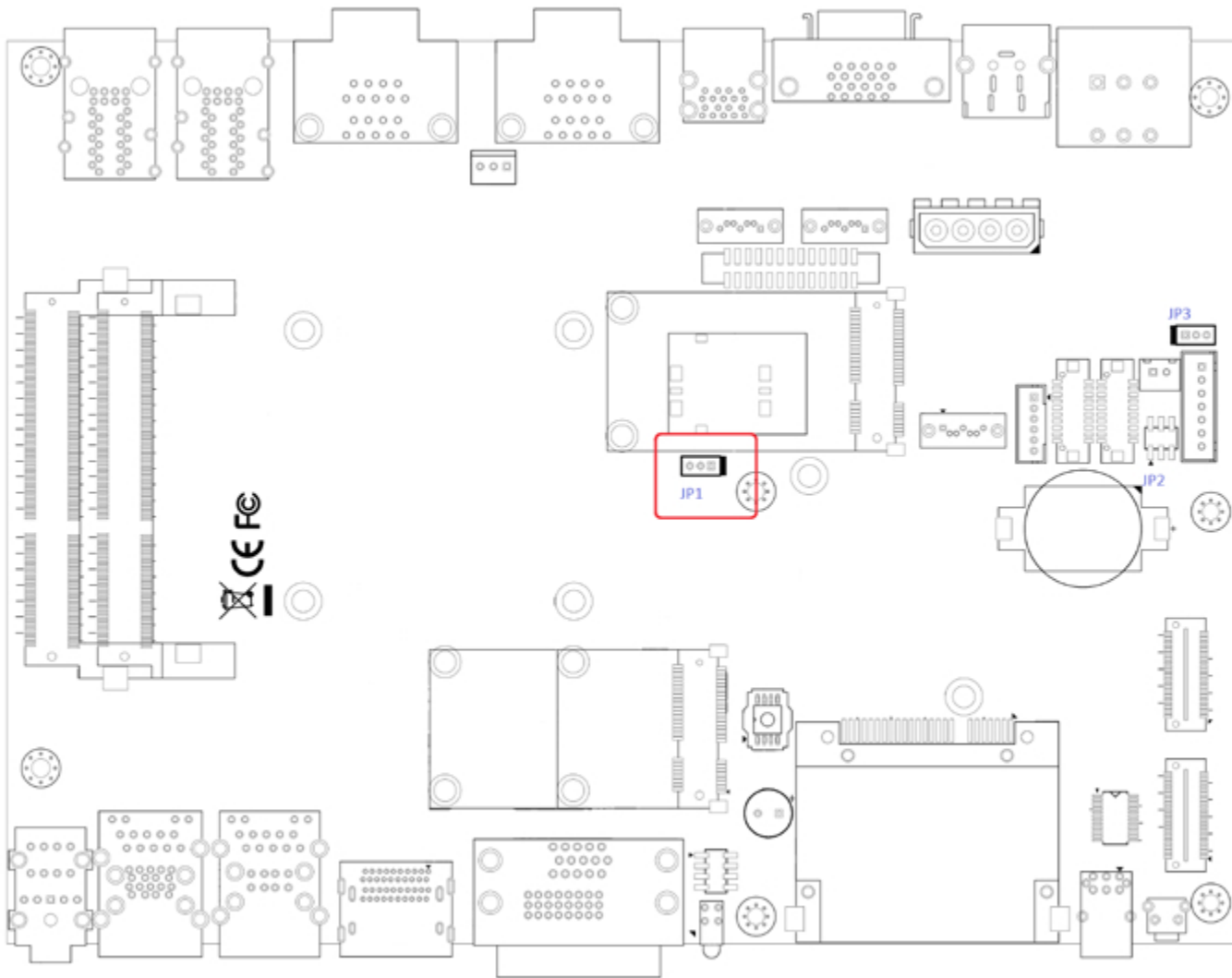

The Echo77F-PoER main board contains a jumper that can switch the AT/ATX Power Setting. Normally this jumper should be set with Pin 4 and Pin 6 in ATX power mode. And power on the system by the 2-pin terminal block at the top panel.

If you set it with Pin 2 and Pin 4 in AT power mode. It will send the power button signal to power on the system automatically

Setting	Description
1-2	AT Mode
2-3	ATX Mode (Default)

3

System Setup

3.1 Install DDR3 / DDR3L SODIMM Modules

Step1.

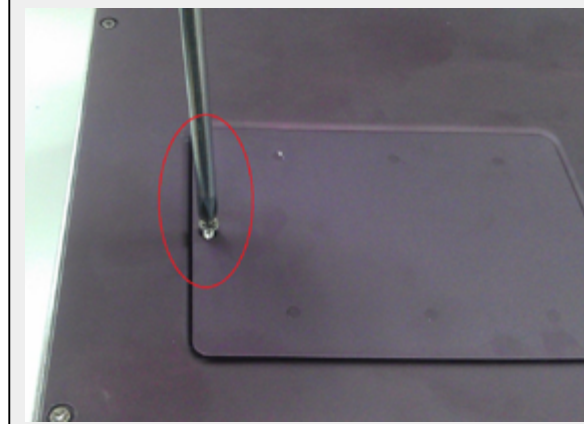

Put the Echo77F-PoER upside down on a flat surface. You can see the "Pet-Door" exposed. Use a Philips screwdriver to loose the M3 flat-head screw on the "Pet-Door".

Step2.



Remove the "Pet-Door" and you can see a SATA cable and DDR3 SODIMM socket exposed.

Step3.

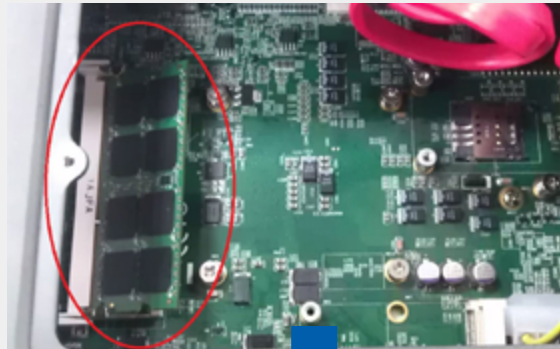

Tile the SODIMM module and insert it to the SODIMM socket.

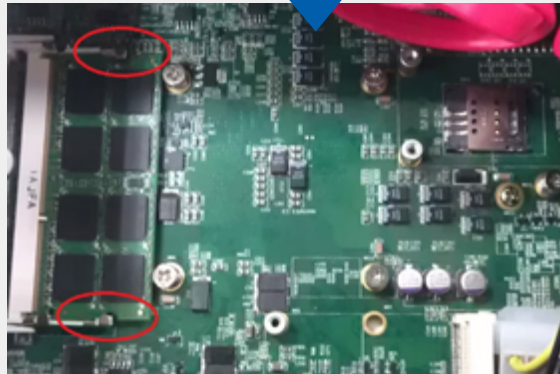

As it's firmly contacted with socket connectors, press it down until the clamps of the socket snap into the latching position of SODIMM module.

3.2 Install HDD

Step1.

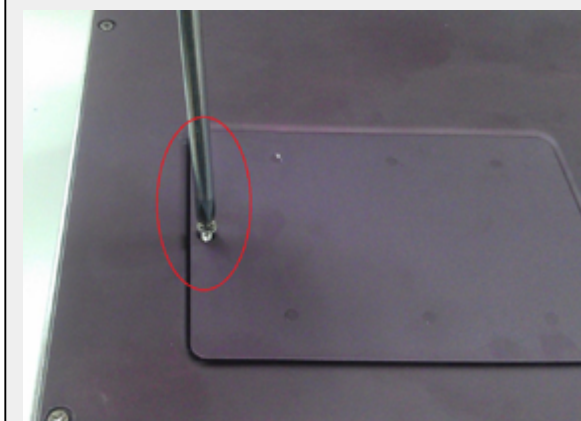

Put the Echo77F-PoER upside down on a flat surface. You can see the "Pet-Door" exposed. Use a Philips screwdriver to loose the M3 flat-head screw on the "Pet-Door".

Step2.



Remove the "Pet-Door" and you can see a SATA cable and DDR3 SODIMM socket exposed.

Step3.



Find the HDD bracket come with "Pet-Door", M3 screws (4 pieces), and HDD thermal pad (1 piece) in the accessory box.

Step4.



Place the HDD into the bracket and gently push it down to make it contact with thermal pad. Use a Philips screwdriver to fix the HDD with M3 screws. Please note that the HDD must be placed in the right direction as below.

Step5.



Pull out the SATA cable inside the chassis and connect it to HDD.

Step 6.

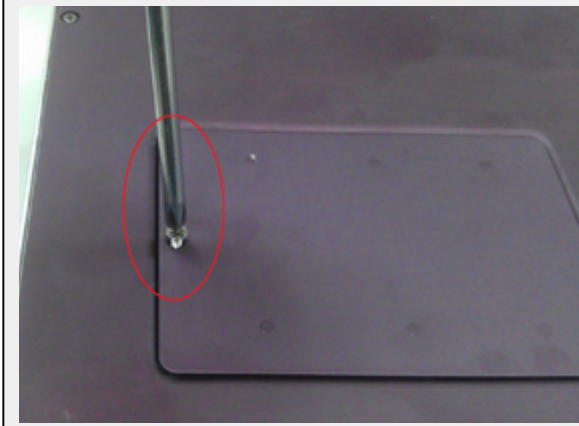

Tilt the HDD assembly and insert the wedge of HDD bracket to the bottom cover. Once it's firmly wedged, push it down and fix it using a M3 flat-head screw.

3.3 Install MiniPCle Cards

Step1.



Use a screwdriver to loose 9 screws on the "Back Panel". Find the BH-M2.5X6 (4 pieces) screws pack in the accessory box.

Step2.

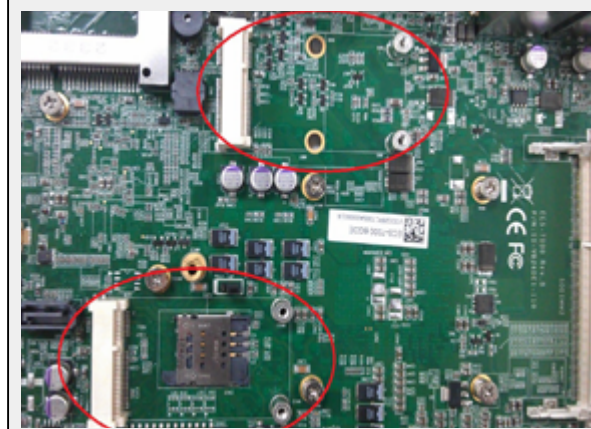

There are 2 Mini-PCle sockets on the main board. Choose one of Mini-PCle socket to put your mini-PCle card in.

Step3.

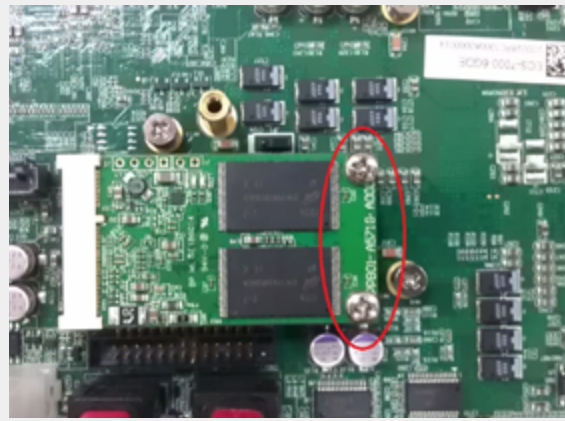

Using 2 BH-M2.5X6 screws to lock your mini-PCIe card firmly. Then you can re-screw the back panel as the first step.

3.4 Install SATA DOM

Step1.



Use a screwdriver to loose 9 screws on the "Back Panel".

Step2.

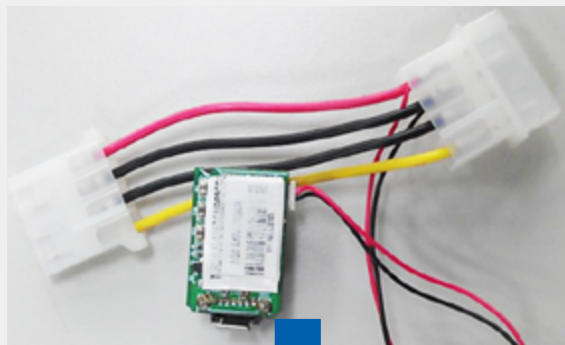

Preparing your SATA DOM and finding 3 SATA DOM connectors on the main board.

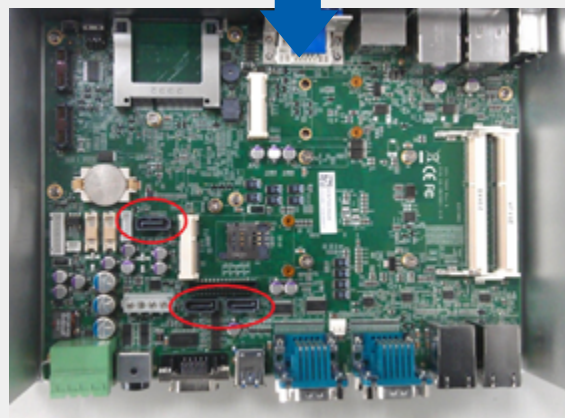

Step3.

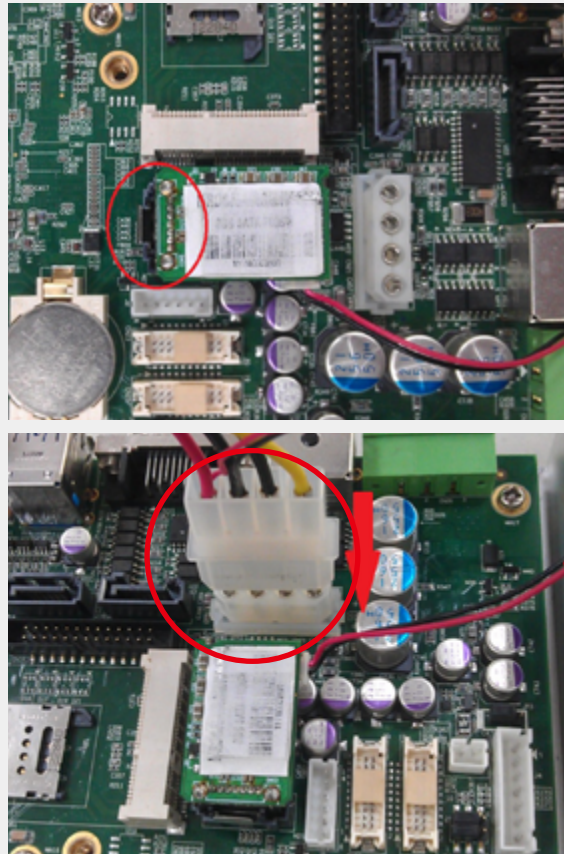

Selecting one of the SATA DOM connector and plug in your SATA DOM.

3.5 Mount Your Echo77F-PoER

Echo77F-PoER is shipped with wall-mount brackets. You can mount your Echo77F-PoER on the wall by following the steps listed below.

Step1.



Put the Echo77F-PoER upside down on a flat surface. Use a Philips screwdriver to loose screw on the back side.

Step2.

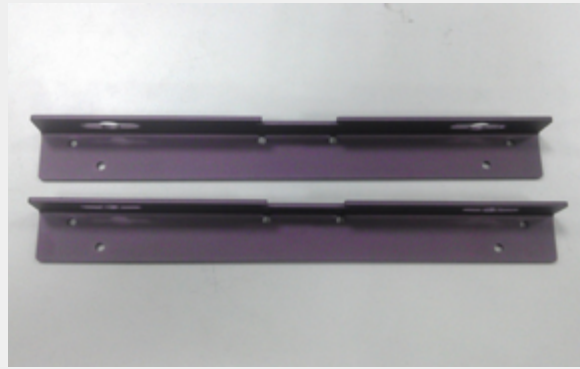

Find your wall-mounts brackets (2 pieces)in the accessory box.

Step3.



Fix two wall-mount brackets to the chassis with four M4 screws using a Philips screwdriver.

Installation Method 1

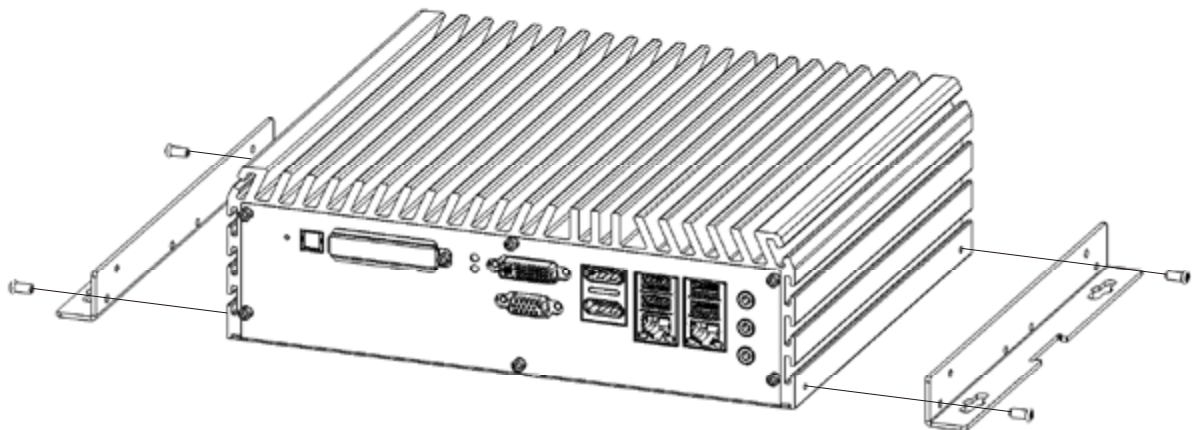

Installation Method 2

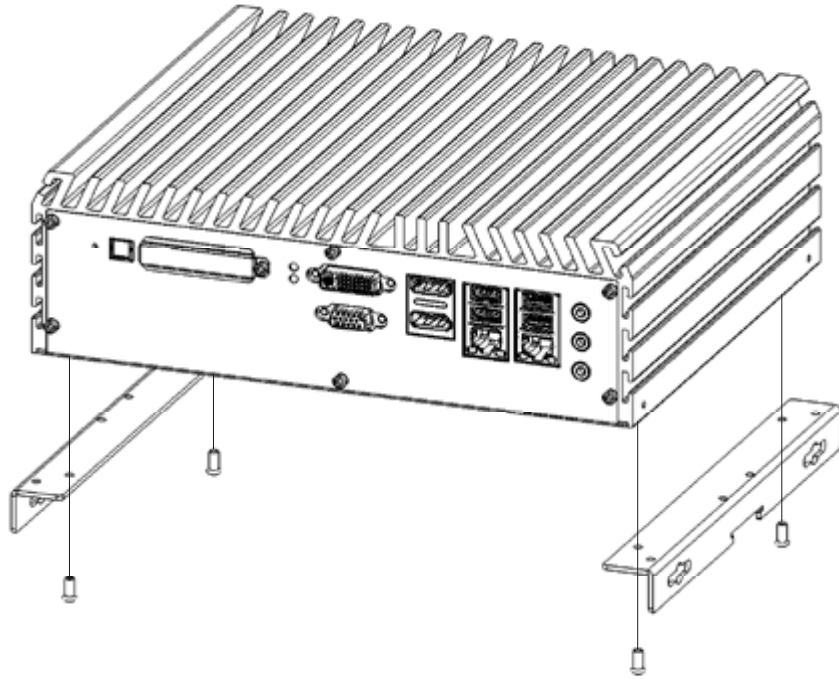

4

BIOS and Driver

4.1 BIOS Settings

The board uses UEFI BIOS that is use Serial Peripheral Interface (SPI) Flash. The SPI Flash contains the BIOS Setup program, POST, the PCI auto-configuration utility, LAN, EEPROM information, and Serial port support. The BIOS setup program is accessed by pressing the <Delete> key after the Power-On Self-Test (POST) memory test begins and before the operating system boot begins. The menu bar is shown below.



Figure 4.1: BIOS Menu Bar

4.1.1 Main Menu

Phoenix SecureCore(tm) Setup Utility					
Main	Advanced	Chipset	Boot	Security	Save & Exit
BIOS Information					Item Specific Help
BIOS Vendor	American Megatrends				
Core Version	4.6.5.3				
Compliance	UEFI 2.3; PI 1.2				
Project Version	1APTJ 0.24 x64				
Build Date and Time	01/24/2013 15:47:32				
Processor information					
Brand String	Intel (R) Core (TM) i7-3610				
System Language	[English]				
System Date	[Thu 02/21/2013]				
System Time	[12:00:00]				
Access Level	Administrator				

Figure 4.2: BIOS Main Screen

System Time / Date : Press "TAB" key to switch sub-items of value .Then press "+" key or "-" key number key for modify value.

4.1.2 Advanced Function

Phoenix SecureCore(tm) Setup Utility					
Main	Advanced	Chipset	Boot	Security	Save & Exit
ACPI Settings					Item Specific Help
Enable ACPI Auto Configuration	[Disabled]				
Enable Hibernation	[Enabled]				

Figure 4.3: ACPI Setting Setup Screen

Enable ACPI Auto Configuration: This system support ACPI function as auto process. You should Enable / Disable that depend as your O.S.

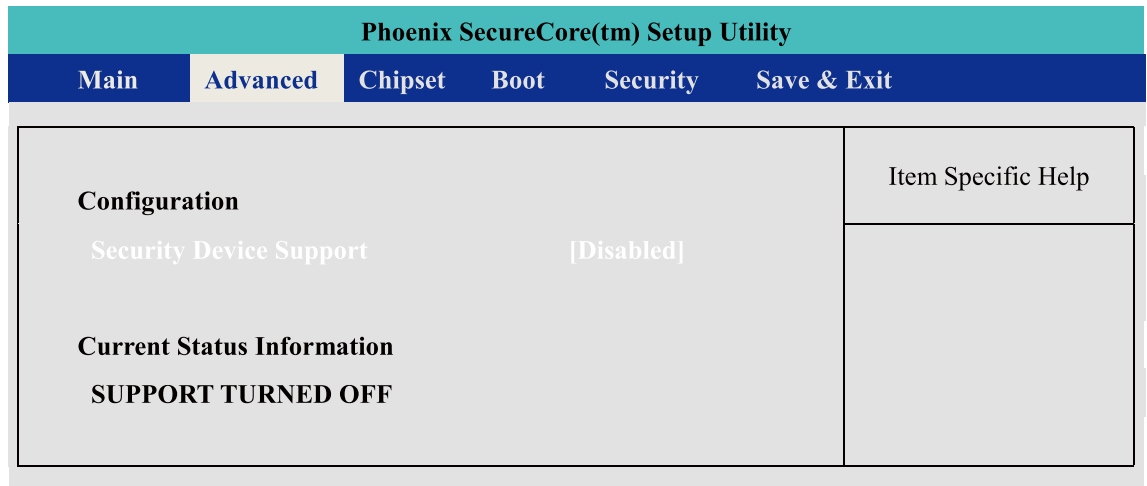

Figure 4.4: Trusted Computing Setup Screen

Security Device Support : Enables or Disables BIOS support for security device. O.S. will now show Security Device. TCG EFT protocol and INT1A interface will not be available.

Current Status Information :

Show as below option

- SUPPORT TURNED OFF
- SUPPORT TURNED ON

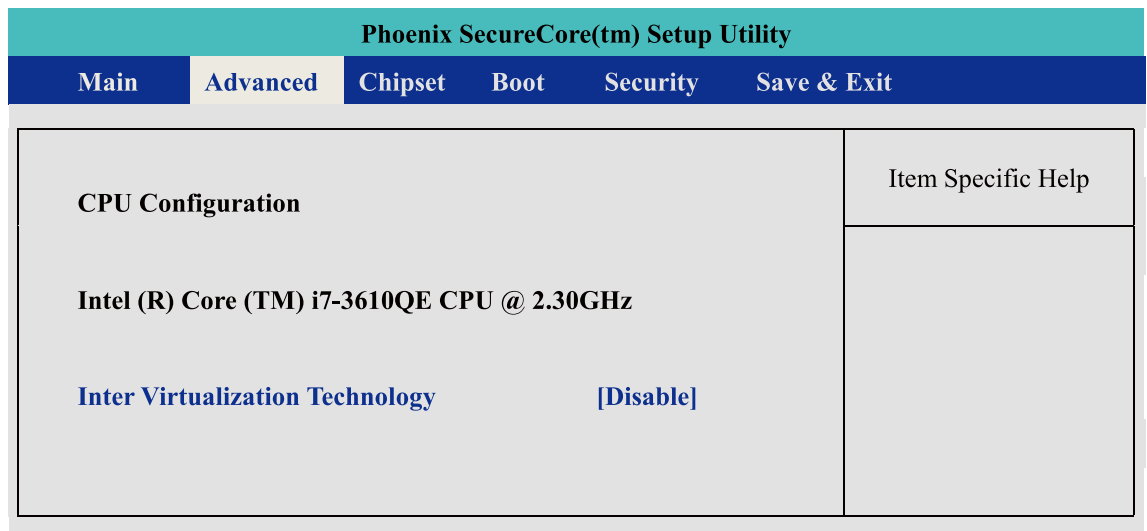

Figure 4.5: Trusted Computing Setup Screen

Intel Virtualization Technology : For Virtualization Application or platform usage, when enabled, a VMM can utilize the additional hardware capabilities provided by Vanderpool Technology,

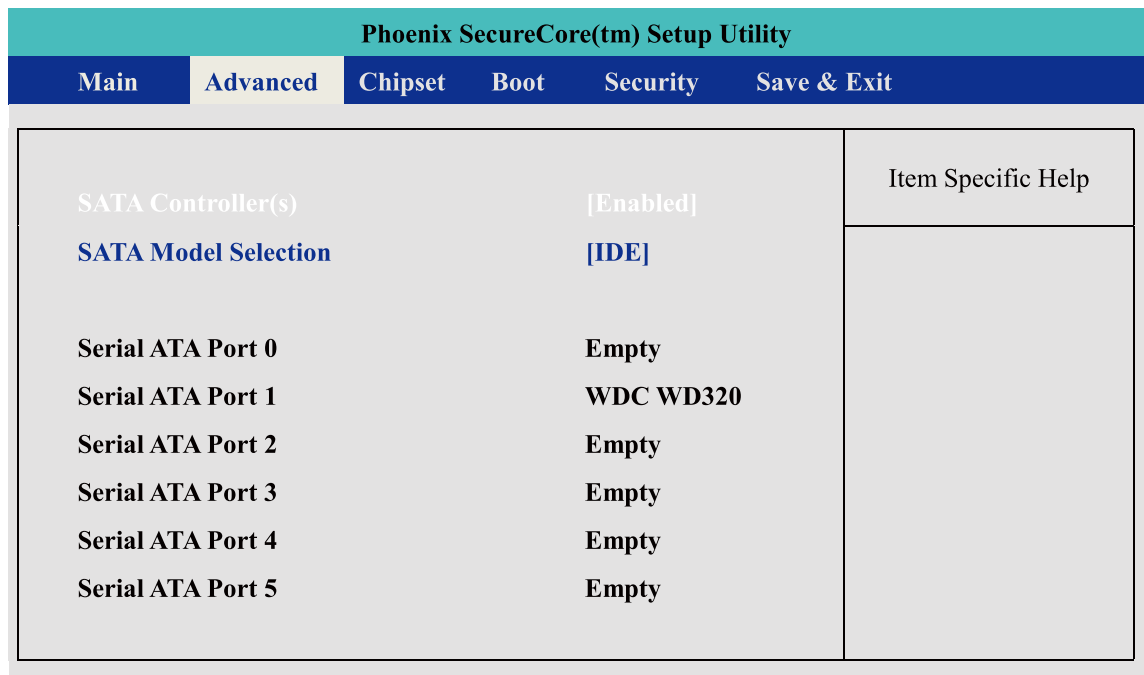

Figure 4.6: SATA Configuration Setup Screen

SATA Controller(s) :

Enables or Disables integrate SATA controller for Storage device use.

SATA Mode Selection :

Determines how the SATA transfer mode for operate. Here have three option for choice [IDE] / [AHCI] / [RAID]. For the RAID mode operate, please see appendix E. for detail information.

Serial Port 0~5 :

This system offers six SATA port for connection SATA device.

Advanced->IT8783F Super IO Configuration->Serial Port 1

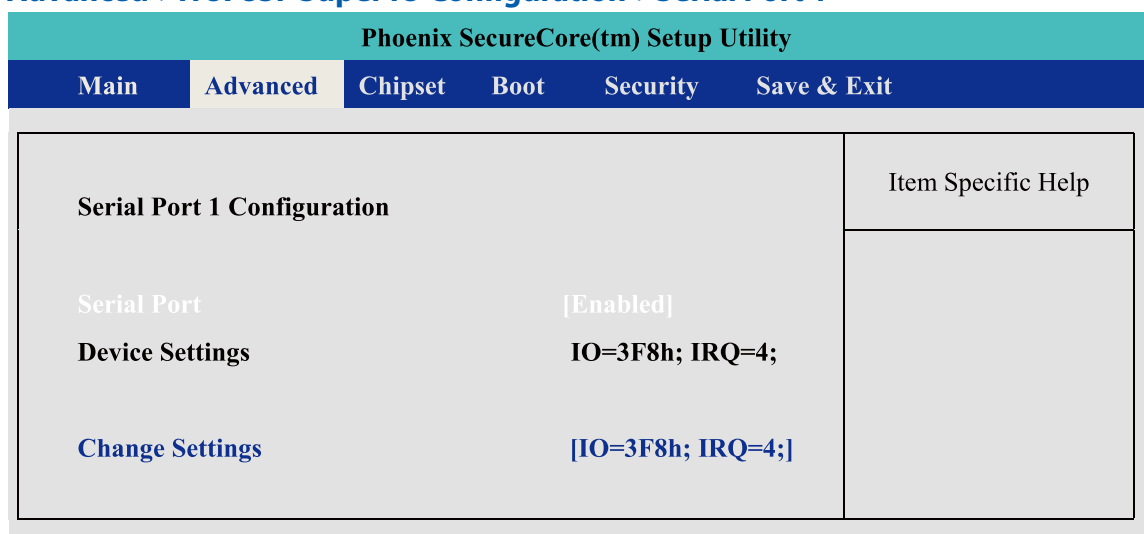

Figure 4.7: Serial Port 1 Setup Screen

Serial Port :

Enable or Disable Serial Port .

Device Setting:

Current IO address and interrupt resource of Serial Port.

Change Settings :

Select another device setting .

Here have 4 option :

IO=3F8h; IRQ=4;

IO=2F8h; IRQ=3;

IO=3E8h; IRQ=10;

IO=2E8h; IRQ=11;

Advanced->IT8783F Super IO Configuration->Serial Port 2

Figure 4.8: Serial Port 2 Setup Screen

Serial Port :

Enable or Disable Serial Port .

Device Setting:

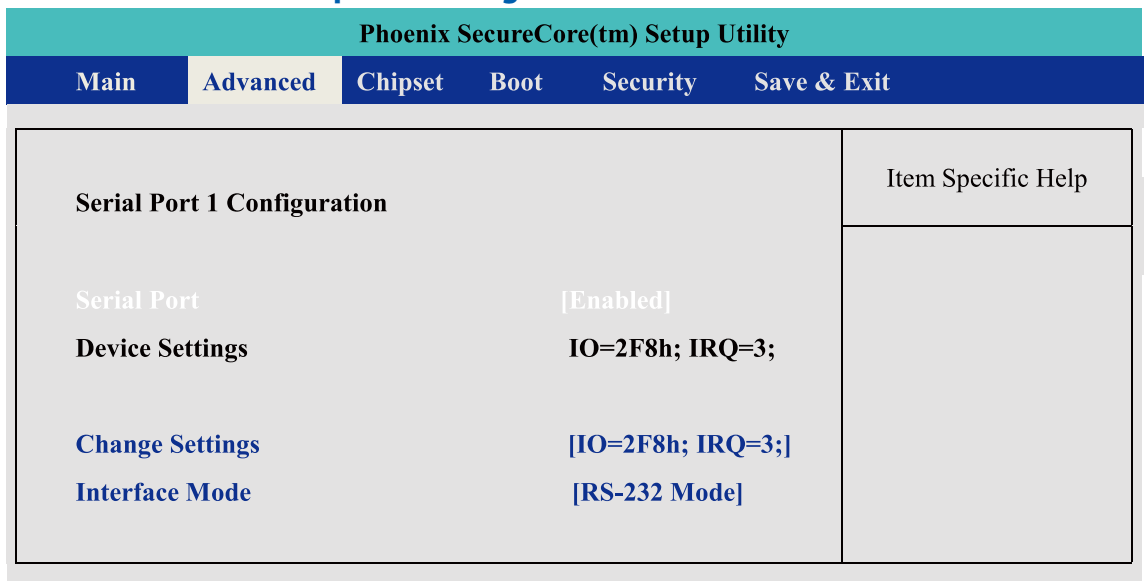
Current IO address and interrupt resource of Serial Port.

Change Settings :

Select another device setting .

Here have 4 option :

IO=3F8h; IRQ=4;

IO=2F8h; IRQ=3;

IO=3E8h; IRQ=10;

IO=2E8h; IRQ=11;

Interface Mode:

Here have 4 option :

RS-232 Mode

RS-422 Mode

RS-485 Mode

Advanced->IT8783F Super IO Configuration->Serial Port 3

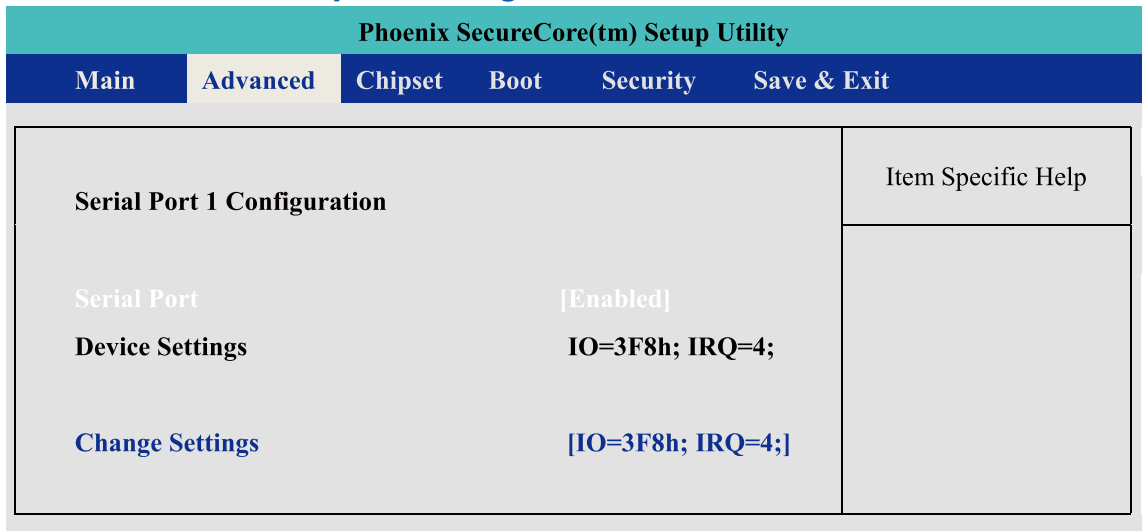

Figure 4.9: Serial Port 3 Setup Screen

Serial Port :

Enable or Disable Serial Port .

Device Setting:

Current IO address and interrupt resource of Serial Port.

Change Settings :

Select another device setting .

Here have 4 option :

IO=3F8h; IRQ=4;

IO=2F8h; IRQ=3;

IO=3E8h; IRQ=10;

IO=2E8h; IRQ=11;

IO=2F0h; IRQ=6;

IO=2E0h; IRQ=7;

Advanced->IT8783F Super IO Configuration->Serial Port 4

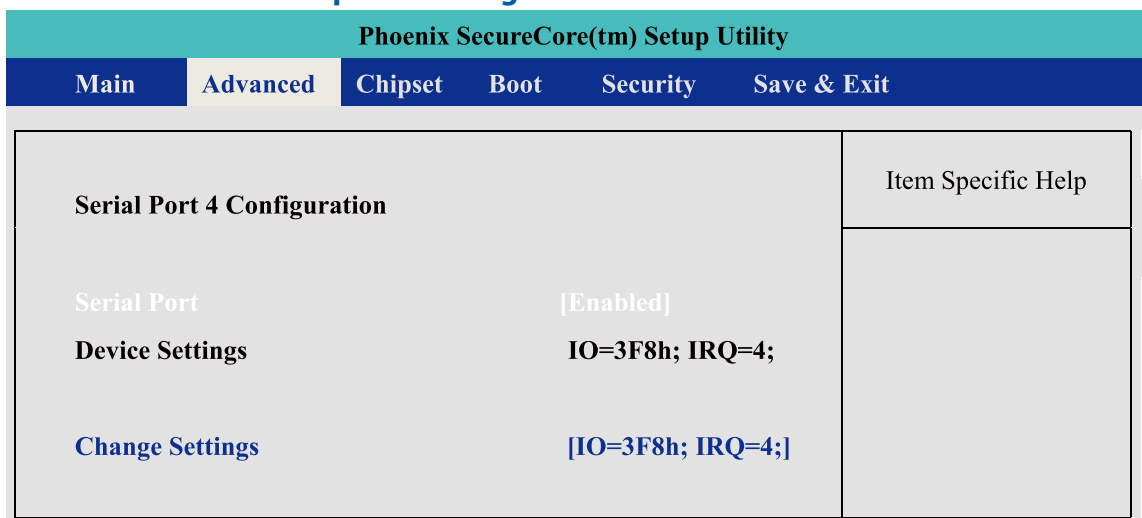

Figure 4.10: Serial Port 4 Setup Screen

Serial Port :

Enable or Disable Serial Port .

Device Setting:

Current IO address and interrupt resource of Serial Port.

Change Settings :

Select another device setting .

Here have 4 option :

IO=3F8h; IRQ=4;

IO=2F8h; IRQ=3;

IO=3E8h; IRQ=10;

IO=2E8h; IRQ=11;

IO=2F0h; IRQ=6;

IO=2E0h; IRQ=7;

4.1.3 Chipset Function



WOL configuration

Chipset->PCH-IO Configuration->Wake on LAN

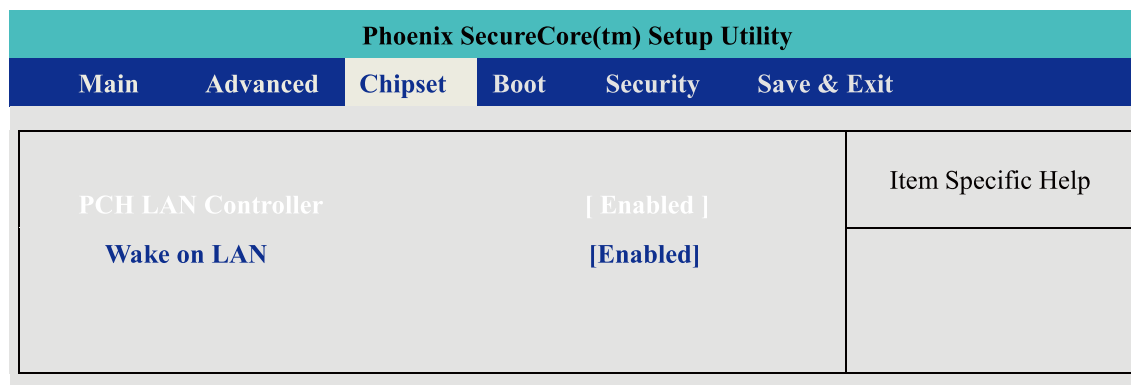

Figure 4.11: Network Setup Screen

PCH LAN Controller : Enable or Disable Serial Port .

Wake on LAN : Enable or Disable integrated LAN to wake the system.
This function also can active by O.S.

Power Loss Configuration

Chipset->PCH-IO Configuration->Restore AC Power Loss

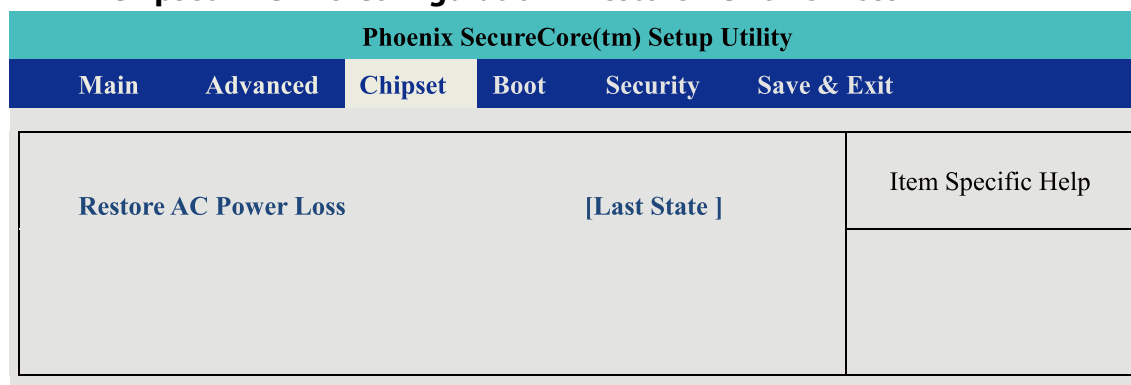

Figure 4.12: Power Loss Setu Screen

PCH LAN Controller :

[Power Off] : When plug-in the power source , system will keep on SB mode.

[Power On] : When plug-in the power source , system will auto booting .

[Last State] : When plug-in the power source , system will keep on last power status.

4.1.4 Boot Function



Boot Option

Chipset->PCH-IO Configuration->Wake on LAN

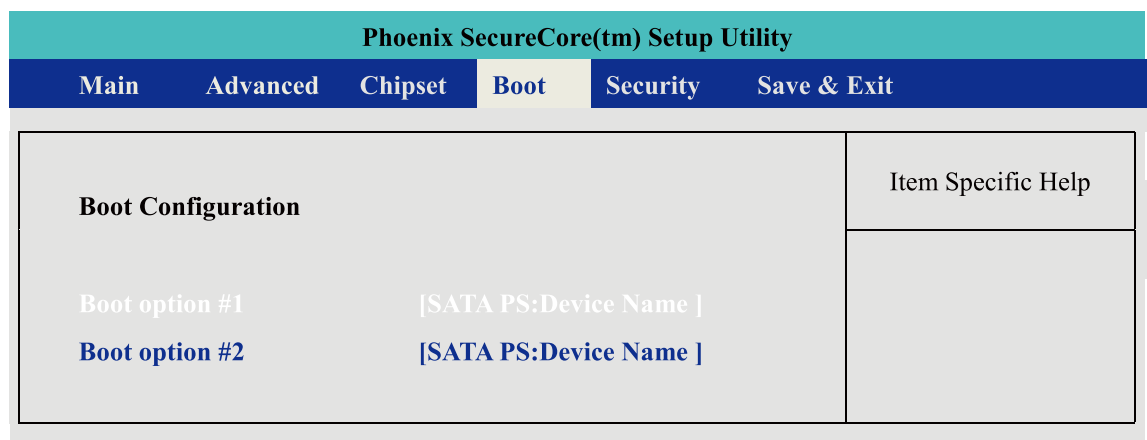

Figure 4.13 Boot Setup Screen

Boot option : When you press "Enter", you can select which device you would like to boot.

4.2 Operating System

Linux :

Ubuntu 10.04LTS or Above

Fedora 13 or Above

And another Linux kernel 2.6.33 and RHL6.0

(* The Linux kernel of RHL , please check RadHat website first)

Windows :

Windows XP

Windows 7 Home/Professional/MediaCenter/

Windows 8 (Do not support RT version)

Windows Server 2008 R2

Windows Server 2012

4.3 Driver Installation

After you setup all hardware and firmware device, you should install the correspond Software driver then active O.S process. When you start to install the driver , please make sure you have administrator ID for system authenticate.

Please follow below sequence for driver install

1. Intel Chipset
2. Intel HD 4000 Graphics
3. Network Device – Include 85574L and 82579LM
4. Audio Driver
5. USB 3.0 support
6. Storage: Include “ACHI” driver and Intel Rapid Storage Software.
7. AMT function of Intel ME(Management Engine)

4.3.1 Chipset Driver Installation

This device software installs all components of Echo77F-PoER platform chipset to the system target system. After install this software, please ensure that as following features function properly:

1. PCIe / PCI . ISAPNP services config.
2. IDE/ACHI storage interface Support
3. USB Support
4. Identification of Intel Chipset Components in the Device Manager.

Install instruction:

Step1.

Find the driver install file

- Windows 7 64bit version :
The Chipset driver location is : [CD]:\Win7\64bit\ChipsetDriver

Step2.

Execute and install the files which matches your operation system. Instruction windows will pop-up when you start to setup the driver, please follow it and complete the setup processes.

Step3.

Once you completed the Intel Chipset Driver setup, please reboot your system , all update function will be active on next time into Windows.

4.3.2 Intel HD 4000 Graphics Driver Installation

This driver will install following features or function properly:

- Display serve
- High definition Audio support

Install instruction:

Step1.

Find the driver install file

- Windows 7 64bit version :

The Graphics driver location is : [CD]:\Win7\64bit\VGADriver

Step2.

Execute and install the files. Instruction windows will pop-up when you start to setup the driver, please follow it and complete the setup processes.

Step3.

Once you completed the HD Graphics Driver Driver setup, please reboot your system , all update function will be active on next time into Windows.

4.3.3 Network Device Driver Installation

This driver will install following features or function properly:

- LAN 1 : Intel 82579LM network device
- LAN 2~ LAN 6 : Intel 82574L network device.
(Please ensure your LAN port number)

Install instruction:

Step1.

Find the driver install file

- Windows 7 64bit version :

The network driver location is : [CD]:\Win7\64bit\LanDriver

Step2.

Execute and install the files. Instruction windows will pop-up when you start to setup the driver, please follow it and complete the setup processes.

Step3.

Once you finish the LAN device Driver setup , the LAN connection will loss for a while and then restart automatically.

Step4.

If you need active AMT function as well , please refer to the section of "AMT driver install".

4.3.4 Audio Driver Installation

This driver will install Realtek High definition device software and Utility.

Step1.

Find the driver install file

The Audio driver location is : [CD]:\Win7\64bit\Audio

Step2.

Execute the install file and start to install it.

Step3.

Once you finish the Audio device Driver setup ,please reboot your system , all update function will be active on next time into Windows.

4.3.5 USB 3.0 Driver Installation

This driver will install USB 3.0 device support software.

Step1.

Find the driver install file

USB 3.0 driver location is : [CD]:\Win7\64bit\USB3.0

Step2.

Execute the install file and start to install it.

Step3.

Once you finish the USB3.0 device Driver setup ,please reboot your system , all update function will be active on next time into Windows.

4.3.6 Storage Support Software Installation

Installing the Intel Rapid software

This driver will install following features or function properly:

CAUTION!

This function only use on AHCI mode.

- Software panel for SATA device
- Utilities for RAID volume creating.

CAUTION!

Step1.

Find the driver install file

Intel Rapid software location is : [CD]:\Win7\64bit\Storage

Step2.

Execute the install file and start to install it.

Step3.

Once you finish the Rapid software setup ,please reboot your system , all update function will be active on next time into Windows.

4.3.7 Intel AMT Function Support

This driver will install following features or function properly:

- Intel ME (Management Engine) support
- Intel AMT software panel
- SOL(Serial on LAN) device driver .

Step1.

Find the driver install file

The Chipset driver location is : [CD]:\Win7\64bit\LanDriver\ME

Step2.

Execute the install file and start to install it.

Step3.

Once you finish the AMT function setup ,please reboot your system , all update function will be active on next time into Windows.

A ppendix A : Isolating DIO Guide

■ Description:

Initialize hardware and resources, and get number of functional boards.

Syntax:

```
l16_mnet104_open ()
```

Argument:

Name	Type	Description
N/C		

Return:

Return Value	Description
ERR_NoError	The function finished execution successfully.
Other	Please reference to the Appendix error table.

■ Description:

Get the local DI value.

Syntax:

```
l16_mnet104_read_port( U16 Offset, U8 *Val )
```

Argument:

Name	Type	Description
Offset	U16	Pointer the access DI port address
Val [output]	U8 *	Return the value of local input interface.

Return:

Return Value	Description
ERR_NoError	The function finished execution successfully.
Other	Please reference to the Appendix error table.

■ Description:

Get the local DI value.

Syntax:

```
l16_mnet104_write_port( U16 Offset, U8 Val )
```

Argument:

Name	Type	Description
Offset	U16	Pointer the access DI port address
Val	U8	Write the value of local input interface.

Return:

Return Value	Description
ERR_NoError	The function finished execution successfully.
Other	Please reference to the Appendix error table.

A

ppendix B : GPIO & WDT Function

The GPIO& WDT are using internal Super IO function. However, you must entry super I/O configuration mode to set it.

The output port is set as GPIO 1 on CN13 , reg. index = **0x60**

The input port is set as GPIO 4 on CN12 , reg. index = **0x62**.

Super I/O special address port = 0x2E

Super I/O special data port = 0x2F

GPIO Logical device is 0x07

A. Entry MB PnP Mode

```
//write twice 0x87 value.  
outportb(Super I/O special address port, 0x87);  
outportb(Super I/O special address port, 0x01);  
outportb(Super I/O special address port, 0x55);  
outportb(Super I/O special address port, 0x55);
```

B. Located on Logical Device 7

```
//write 0x07 on Reg [0x07] , this setup must follow Step A. that can be workable.  
outportb(Super I/O special address port, 0x07);  
outportb(Super I/O special data port, 0x07);
```

C. Access the Super I/O Register

Base control for write Super I/O register.

```
outportb(special address port, Register Index.);  
outportb(special data port, update_value);
```

Base control for read Super I/O register

```
outportb(special address port, Register Index.);  
inportb(special data port); //It will return a BYTE value.
```

D. Start to Access the Echo77F-PoER GPIO Port

Please refer to source code for set_data() and get_data() function.

Write data to GPO(output) port

```
set_data( Register Index , update_value);
```

example :

```
unsigned char data = 0x82;
```

```
set_data( 0xE5 , data);
```

```
//Set bit 7 & bit 1 of GPO output port as High level ,another bit is Low
```

Please refer to source code for set_data() and get_data() function.

Read data to GPI(input) port

get_data(Register Index) //It will return a BYTE value.

example :

unsigned char data

get_data(0xF1 , data);

//Get GPI(input) port status on input_data variable.

E. WDT ON/OFF and Timer-Counter setting

Refer to GPIO setting of Step A and B. , located Logical 0x08 for WDT function.

Reg [0x30] is WatchDog ON/OFF control.

WatchDog On : set_data(0x30 , 0x01);

WatchDog Off : set_data(0x30 , 0x00);

Reg [0xF0] is WatchDog timer - counterON/OFF control.

WatchDog counter start : set_data(0xF0 , 0x02);

WatchDog counter start : set_data(0xF0 , 0x00);

Reg [0xF1] is WatchDog time-out value, "Reading" this register returns the current value in the Watch Dog Counter, not the Watch Dog Timer Time-out value..

WatchDog time-out value : set_data(0xF1 ,);